

## User Guide

### MD500 Series

19011287 A02

### PROFINET Expansion Card

#### Option for the MD Series AC Drive

1

### 1. Overview

Thank you for using Inovance's MD series AC drives and MD500 PROFINET expansion card (hereinafter referred to as the MD500-PN1 card).

The MD500-PN1 card is a PROFINET field bus adapter card complying with the international PROFINET standard. It is installed in the MD series AC drive to increase the communication efficiency and implement the AC drive networking function, which enables the AC drive to be a slave controlled by the field bus master station. The MD500-PN1 card is designed for the following AC drives: MD500, MD290, MD480 (3.7 kW and above), MD380 (3.7 kW and above), CS710, CS290, and MD500-PLUS.

The MD500-PN1 card software version required in this user guide is 1.00 or above (checked by U0-67 on MD500 after the card is installed and powered on). The corresponding GSDML file is named **GSDML-V2.31-inovance-md500-20180705.xml**. In this user guide, the MD500 series AC drive is used as an example to describe the usage of the MD500-PN1 card. If you need to use it on other AC drives, contact our technical engineers to check whether available and obtain corresponding information.

Before using the product, read this user guide thoroughly.

### 2. Installation and Settings

#### ■ Installing the MD500-PN1 card

The MD500-PN1 card is installed inside the MD500 series AC drive. Before installation, de-energize the AC drive and wait about 10 minutes until the charging indicator on the AC drive becomes off. Then, insert the MD500-PN1 card into the AC drive and fasten the screws to avoid damage caused by external signal cable tension on the signal socket between boards. Figure 1 shows the installation.

Note that the ground terminals of both the MD500-PN1 card and AC drive must be connected properly, as shown in Figure 2.

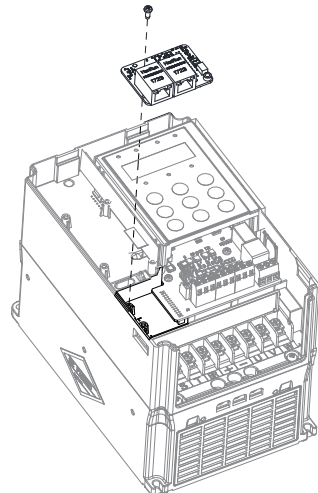

Figure 1 Installation of the MD500-PN1 card

2

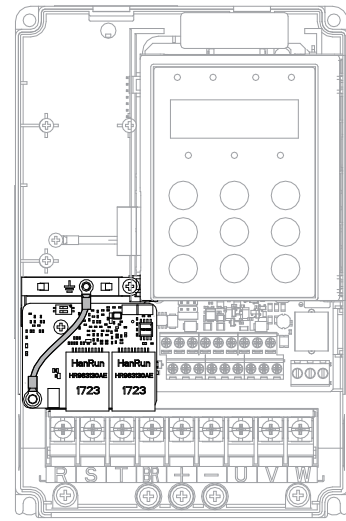

Figure 2 Ground terminal connection between the MD500-PN1 card and AC drive

#### ■ Hardware layout

Figure 3 shows the hardware layout of the MD500-PN1 card. The pin header J1 on the back of the MD500-PN1 card is used to connect the AC drive. The MD500-PN1 card provides two network ports J2 and J3 for communication with the PROFINET card (PLC). For details about the hardware, see Table 1.

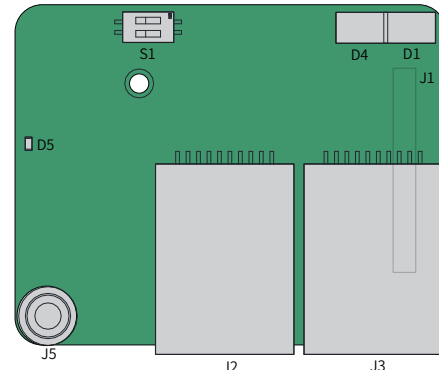

Figure 3 MD500-PN1 card (hardware)

Table 1 Hardware description of the MD500-PN1 card

Symbol	Hardware Name	Function Description
J1	Pin header	Used to connect the AC drive.
J2	Network port	Used to communicate with the PROFINET card (PLC), direction insensitive.
J3	Network port	Used to communicate with the PROFINET card (PLC), direction insensitive.
J5	EMC ground terminal	Used to connect the EMC ground terminal of the AC drive.
D5	Power indicator	Used to indicate the power status. On: power-on normal Off: power-on abnormal (Check whether the installation is correct.)
D1	PLC communication status indicator (PLCLINK)	See "Table 2 Indicator description of the MD500-PN1 card".
D4	AC drive communication status indicator (DSPLINK)	See "Table 2 Indicator description of the MD500-PN1 card".
S1	Two-bit DIP switch	Used for upgrade by the manufacturer only.

3

Table 2 Indicator description of the MD500-PN1 card

Indicator	State Description	Solution	
DSPLINK	Steady green	Normal	N/A
	Steady yellow	MAC address abnormal	Replace the MD500-PN1 card.
	Flashing yellow	AC drive faulty	Clear the AC drive fault.
	Steady red	Abnormal communication with the AC drive	Set F0-28 to 1 and check whether the AC drive supports the MD500-PN1 card.
	Flashing red	AC drive communication timeout	Check whether the AC drive software version supports the MD500-PN1 card. Restore the AC drive software to default settings.
PLCLINK	Steady green	Communication normal	N/A
	Flashing green	Master station not found	Check whether a device name is assigned to the slave. Check whether the corresponding PLC is connected.
	Steady yellow	Configuration error	Check whether the GSD is correct.
	Steady red	Communication with the master station interrupted	Check the wiring and check whether the shield layer of the network cable is connected properly.
D1 and D4	Both in red	MD500-PN1 card software abnormal	Power off and then on the equipment. Replace the MD500-PN1 card.
		DIP switch abnormal	Check that the DIP switch S1 is OFF and re-power on the equipment.

#### ■ PROFINET RJ45 interface

The MD500-PN1 card is connected to the PROFINET master station using the standard Ethernet RJ45 socket. Its pin signal definitions are the same as those of the standard Ethernet pins. They can be connected using crossover cables or straight-through cables.

Table 3 PROFINET communication terminal description

Terminal ID	Terminal Name	Description
J2	Network port P1	Direction-insensitive terminals, either of them connected to the PLC
J3	Network port P2	Direction-insensitive terminals, either of them connected to the PLC



NOTE

- ◆ After the MD500-PN1 card is installed, J2 is on the left and J3 is on the right when facing to the RJ45 interface.
- ◆ The Cat5e shielded twisted pair (STP) network cable is recommended for ensuring stability.

### 3. Communication Configuration

#### ■ Communication configuration for the MD500-PN1 card and AC drive

After installing the MD500-PN1 card to the AC drive, complete communication configuration to enable the communication between them.

##### ◆ Communication card settings for the AC drive

The communication settings for different AC drives vary as follows:

- 1) Communication card settings for the MD500, MD290, MD480, and MD380 series AC drives

After powering on the AC drive, set F0-28 to 1 to enable communication between the MD500-PN1 card and the AC drive.

Param. No.	Param. Name	Setting Range	Value	Meaning
F0-28	Serial port communication protocol	0: Modbus protocol 1: Communication card network bridge protocol	1	Select the special communication card network bridge for the serial communication protocol.

- 2) Communication card settings for the MD500-PLUS series AC drives

After powering on the AC drive, set Fd-00 to 9 (baud rate: 115200 bps) and Fd-01 to 3 (no check, 8-N-1) to enable communication between the MD500-PN1 card and the AC drive.

4

3) Communication card settings for the CS710 and CS290 series AC drives  
After powering on the AC drive, set bd.07 to 2 to enable communication between the MD500-PN1 card and the AC drive.

Param. No.	Param. Name	Setting Range	Value	Meaning
bd.07	Expansion card selection	0: Modbus protocol 1: PROFIBUS-DP 2: CANopen/ PROFINET	2	PROFINET communication expansion card

##### ◆ Parameters related to communication control

Param. No.	Param. Name	Setting Range	Decimal Address
U3-16	Frequency setting	-Maximum frequency to +Maximum frequency 0.01 Hz	29456
U3-17	Control command	0001: Forward running 0002: Reverse running 0003: Forward jogging 0004: Reverse jogging 0005: Coast to stop 0006: Decelerate to stop 0007: Fault reset	29457
U3-18	DO control	BIT0: DO1 control BIT1: DO2 control BIT2: RELAY1 control BIT3: RELAY2 control BIT4: FMR output control BIT5: VDO1 BIT6: VDO2 BIT7: VDO3 BIT8: VDO4 BIT9: VDO5	29458
U3-19	AO1 control	0 to 7FFF indicates 0% to 100%.	29459
U3-20	AO2 control	0 to 7FFF indicates 0% to 100%.	29460
U3-21	FMR control	0 to 7FFF indicates 0% to 100%.	29461
U3-22	Reserved	Reserved	-
U3-23	Speed control	Signed data, 1 rpm	29463

By default, when the MD500-PN1 card is used, the written PZD1 and PZD2 are mapped to U3-17 and U3-16, respectively. If any command or frequency cannot be written into the AC drive correctly but PZD3 to PZD12 can be written and F0-02 and F0-03 are set to 2 and 9 respectively, check whether FE-00 and FE-01 are set to U3-17 and U3-16 respectively. If not, manually correct the values of FE-00 and FE-01.

##### ◆ Parameters related to communication monitoring

Param. No.	Parameter Name	Unit	Decimal Address
U0-00	Running frequency (Hz)	0.01 Hz	28672
U0-01	Frequency reference (Hz)	0.01 Hz	28673
U0-02	Bus voltage (V)	0.1 V	28674
U0-03	Output voltage (V)	1 V	28675
U0-04	Output current (A)	0.01 A	28676
U0-05	Output power (kW)	0.1 kW	28677
U0-06	Output torque (%)	0.1%	28678
U0-07	DI state	1	28679
U0-08	DO state	1	28680
U0-09	AI1 voltage (V)	0.01 V	28681
U0-10	AI2 voltage (V)	0.01 V	28682
U0-11	AI3 voltage (V)	0.01 V	28683
U0-12	Count value	1	28684
U0-13	Length value	1	28685
U0-14	Load speed display	1	28686
U0-15	PID reference	1	28687
U0-16	PID feedback	1	28688
U0-17	PLC stage	1	28689
U0-18	Pulse input frequency (Hz)	0.01 kHz	28690
U0-19	Feedback speed (Hz)	0.01 Hz	28691
U0-20	Remaining running time	0.1 min	28692
U0-21	AI1 voltage before correction	0.001 V	28693

5

Param. No.	Parameter Name	Unit	Decimal Address
U0-22	AI2 voltage before correction	0.001 V	28694
U0-23	AI3 voltage before correction	0.001 V	28695
U0-24	Linear speed	1 m/min	28696
U0-25	Current power-on time	1 min	28697
U0-26	Current running time	0.1 min	28698
U0-27	Pulse input frequency	1 Hz	28699
U0-28	Communication setting	0.01%	28700
U0-29	Encoder feedback speed	0.01 Hz	28701
U0-30	Main frequency X display	0.01 Hz	28702
U0-31	Auxiliary frequency Y display	0.01 Hz	28703
U0-32	Any memory address	1	28704
U0-33	Synchronous motor rotor position	0.1°	28705
U0-34	Motor temperature	1°C	28706
U0-35	Target torque (%)	0.1%	28707
U0-36	Resolver position	1	28708
U0-37	Power factor angle	0.1°	28709
U0-38	ABZ position	1	28710
U0-39	Target voltage upon V/F separation	1 V	28711
U0-40	Output voltage upon V/F separation	1 V	28712
U0-41	DI state display	1	28713
U0-42	DO state display	1	28714
U0-43	DI state display 1	1	28715
U0-44	DI state display 2	1	28716
U0-45	Fault information	1	28717
U0-58	Phase Z counting	1	28730
U0-59	Frequency reference (%)	0.01%	28731
U0-60	Running frequency (%)	0.01%	28732
U0-61	AC drive state	1	28733
U0-62	Current fault code	1	28734
U0-63	Running frequency after droop control	0.01 Hz	38375
U0-64	Current back EMF	0.1 V	28736
U0-65	Reserved	-	-
U0-66	Expansion card model	100: CANopen 200: PROFIBUS-DP 300: CANlink 400: PROFINET 500: EtherCAT	28738
U0-67	Expansion card version number	0.01	28739
U0-68	AC drive state	1	28740
U0-69	Running frequency (Hz)	0.01 Hz	28741
U0-70	Motor speed	1 rpm	28742
U0-71	Output current	0.1 A	28743

By default, when the MD500-PN1 card is used, the read PZD1 and PZD2 are mapped to U0-68 and U0-69, respectively. If any state or running frequency cannot be read correctly but PZD3 to PZD12 can be read, check whether FE-20 and FE-21 are set to U0-68 and U0-69 respectively. If not, manually correct the values of FE-20 and FE-21.



NOTE

For the CS710 series AC drive, the corresponding addresses for reading U0.00 (Frequency reference) and U0.10 (DI state) are 16#D000 (53248 in decimal format) and 16#D00A (53258 in decimal format), respectively.  
For the PZD definitions of other series AC drives, see the corresponding user guides.

#### ■ Communication configuration for the MD500-PN1 card and PROFINET master station

After enabling the communication between the MD500-PN1 card and AC drive, connect the PROFINET master station correctly to enable the communication between the MD500-PN1 card and PROFINET master station and networking function of the AC drives.



PROFINET topology

The topological structures supported by PROFINET include bus, star, and tree topologies. Various networking can be realized by using switches correctly.

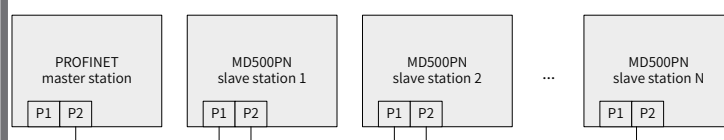

Figure 4 Bus topology

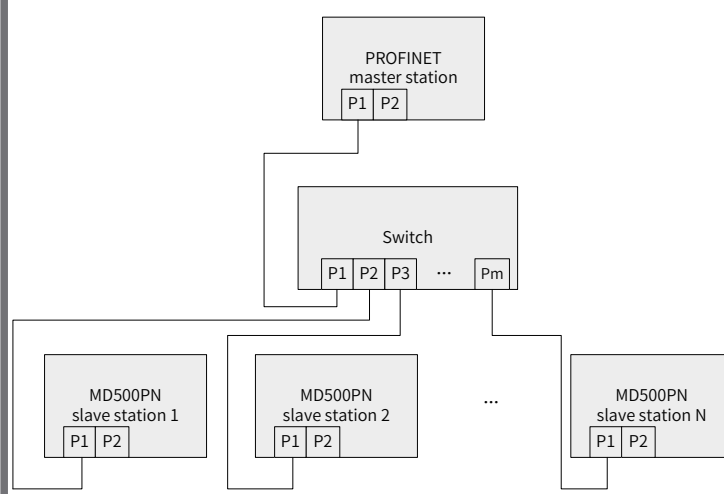

Figure 5 Star topology

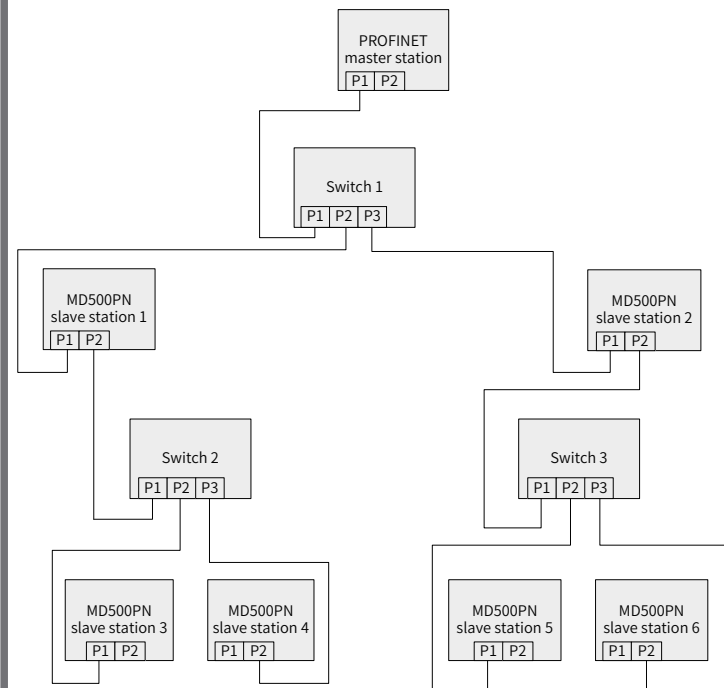

Figure 6 Tree topology

PROFINET communication protocol

Data transmission format:

The MD500-PN1 card transmits data using PZD formats with different lengths as required. You can set the PZD functions during configuration.

The following table lists the functions supported by each data format.

Table with 3 columns: Data Format, Data Length, Supported Function. Rows include Standard telegram 1, 2, and 3 with their respective PZD lengths and functions.

Table with 3 columns: Data Format, Data Length, Supported Function. Rows include Standard telegram 4, 5, 6, and Supplementary telegram with their respective PZD lengths and functions.

PZD data description

The PZD data is used for the master station to modify and read AC drive data in real time and perform periodic data exchange. Data communication addresses are directly configured by the AC drive. The specific functions are as follows:

- 1) Real-time setting of AC drive control command and target frequency
2) Real-time reading of AC drive current state and running frequency
3) Real-time exchange of function parameter and monitor data between the AC drive and PROFINET master station

The PZD is used for periodic data exchange between the master station and AC drive, as described in the following table.

Two tables: 'Master sending data PZD' and 'AC drive response data PZD'. The first table maps AC drive commands to PZD1-PZD12. The second table maps AC drive responses to PZD1-PZD12.

Data sent by the master station

The data sent by the AC drives varies depending on the series.

- 1) MD500, MD500-PLUS, MD290, MD480, and MD380 series AC drives

Table with 3 columns: PZD, AC drive command, AC drive response. Rows include PZD1, PZD2, and PZD3 to PZD12 with detailed descriptions of data sent by the master station.

- 2) CS710 and CS290 series AC drives

Table with 3 columns: PZD, Master sending data PZD, AC drive response data PZD. Rows include PZD1 with detailed descriptions of data sent by the master station for CS710 and CS290 series.

Table with 3 columns: PZD, Master sending data PZD, AC drive response data PZD. Rows include PZD2 and PZD3 to PZD12 with detailed descriptions of data sent by the master station.

AC drive response data

The AC drive response data varies depending on the series.

- 1) MD500, MD500-PLUS, MD290, MD480, and MD380 series AC drives

Table with 3 columns: PZD, AC drive response data PZD, AC drive running state. Rows include PZD1 and PZD2 with detailed descriptions of data sent by the master station.

Table with 3 columns: PZD, AC drive response data PZD, AC drive running state. Rows include PZD1 and PZD2 with detailed descriptions of data sent by the master station.

Table with 3 columns: PZD, AC drive response data PZD, AC drive running state. Rows include PZD1 and PZD2 with detailed descriptions of data sent by the master station.

Table with 3 columns: PZD, AC drive response data PZD, AC drive running state. Rows include PZD2 and PZD3 to PZD12 with detailed descriptions of data sent by the master station.

Configuring a slave station on the S7-1200 master station

When using the PROFINET master station, configure the GSDML file (obtained from Inovance's agency or manufacturer) of the slave station first to add the slave device to the master station system.

- Step 1: Create a project and add the S7-1200 master station to the project in PORTAL by performing the following substeps. Open PORTAL, as shown in the following figure.

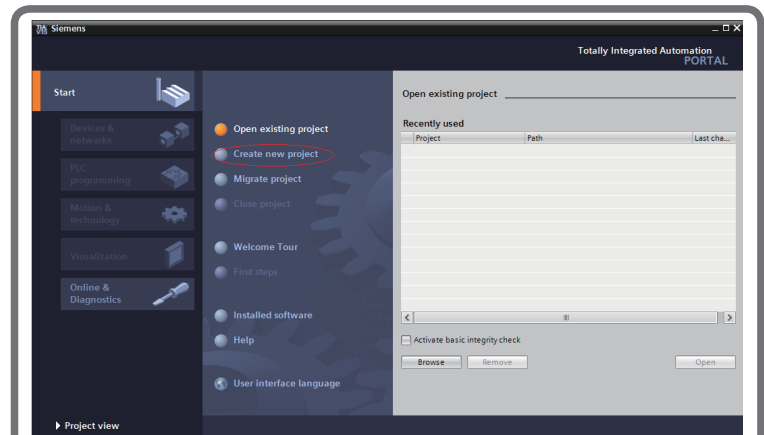

Click Create new project, enter a project name and storage path, and click Create.

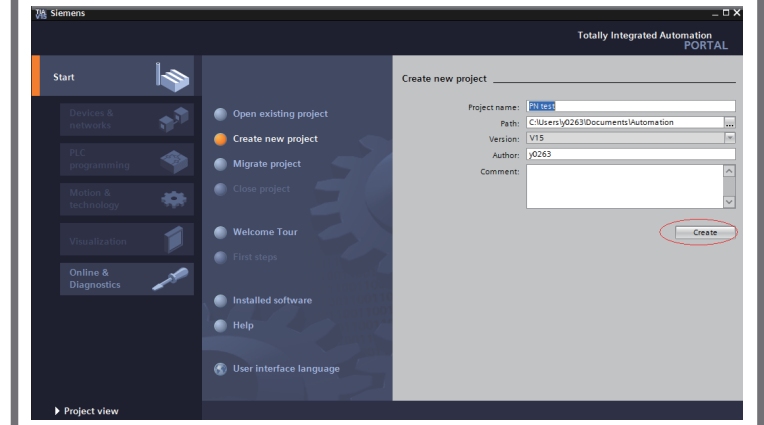

Click Configure a device, as shown in the following figure.

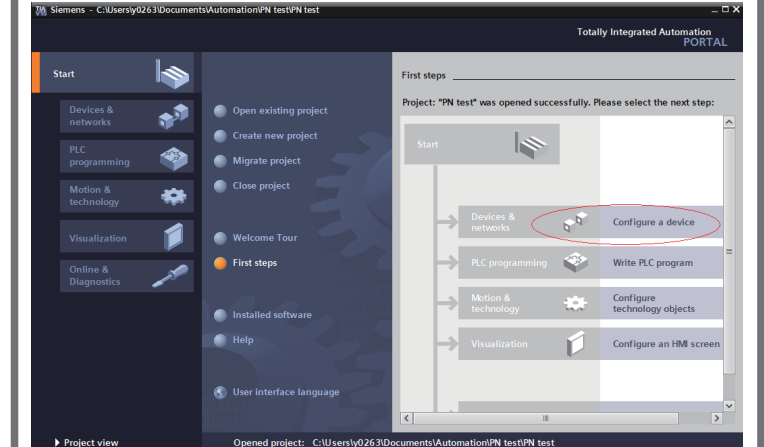

For a new project, click Add new device (marked by a red circle in the following figure). For an existing project, click Configure networks (marked by a green circle in the following figure).

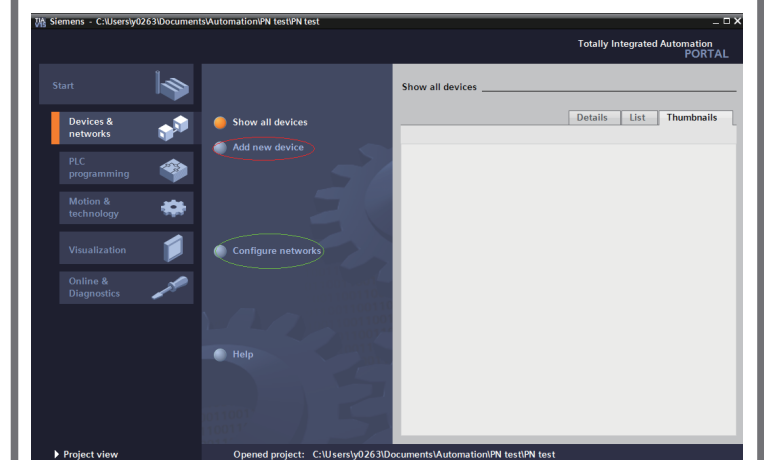

Select a PLC on the displayed page. Note that the article number must be correct and select the corresponding firmware version for the PLC to avoid download failure.

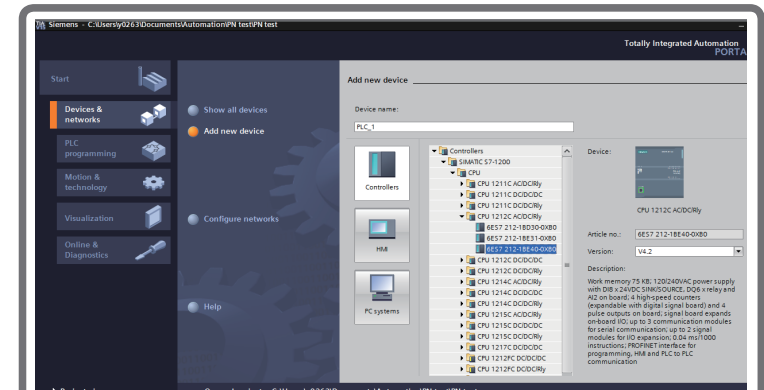

Click Add or double-click the selected master station, as shown in the following figure.

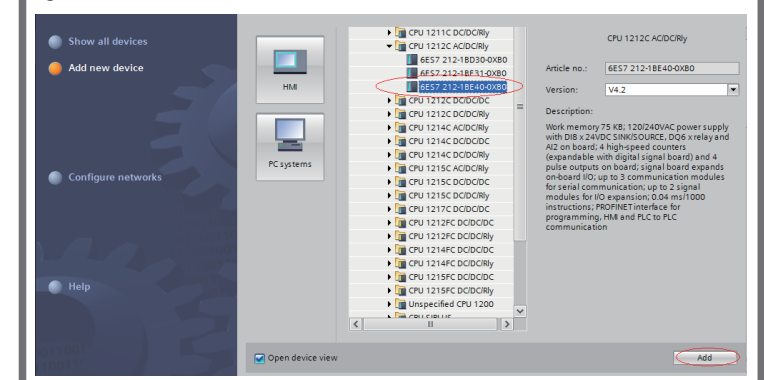

Now the master station is established.

Step 2: Install the GSDML file. (If the GSDML file has been installed, skip this step.) Choose Options > Manage general station description files (GSD).

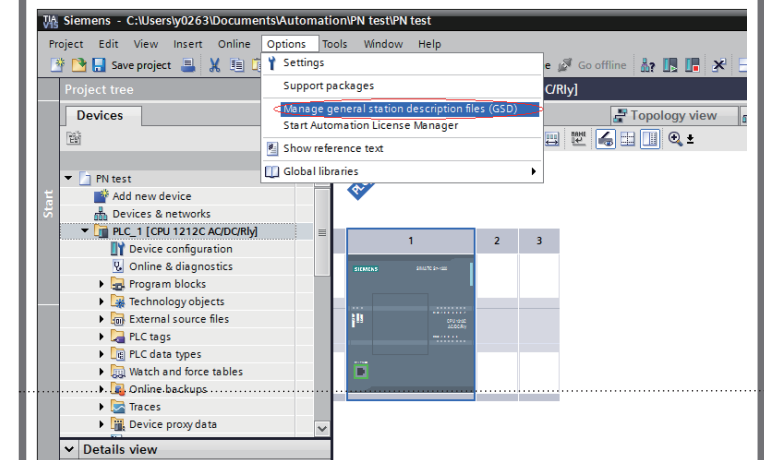

Select the storage path (English path required) of the GSDML file, select the GSDML file to be installed, and click Install.

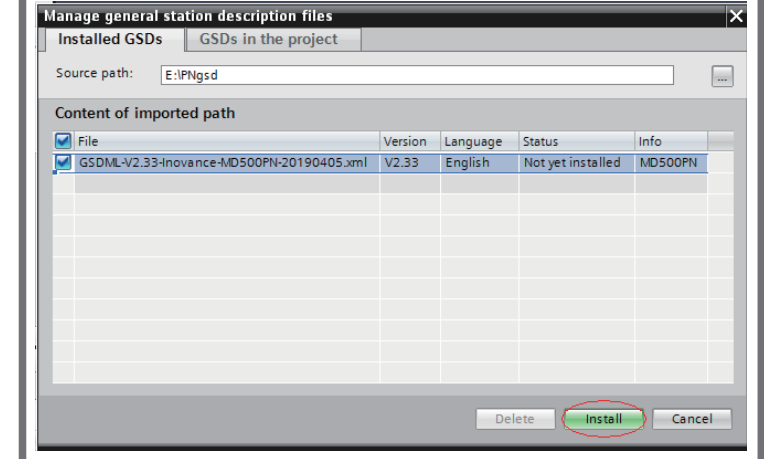

After the successful installation information is displayed, click Close.

NOTE The GSDML file names vary with the AC drive series. For details, see the corresponding user guides.

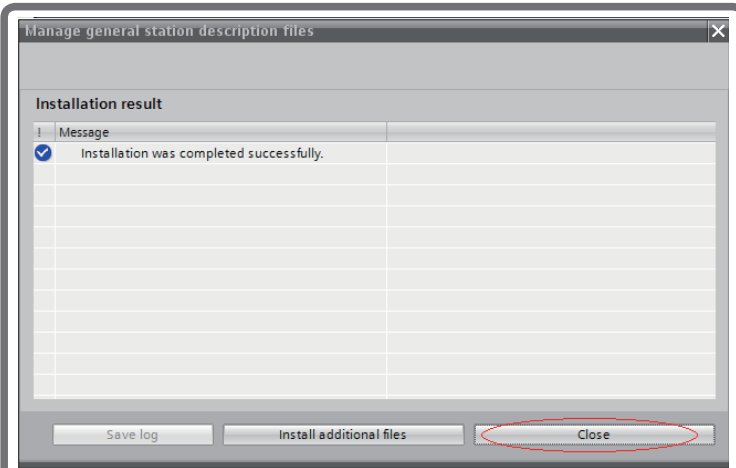

Step 3: Configure the slave station.  
Click **Device configuration** on the page.

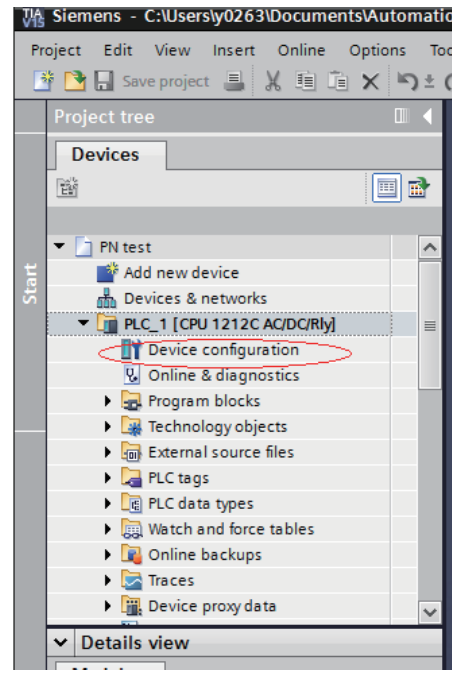

Click **Network view**.

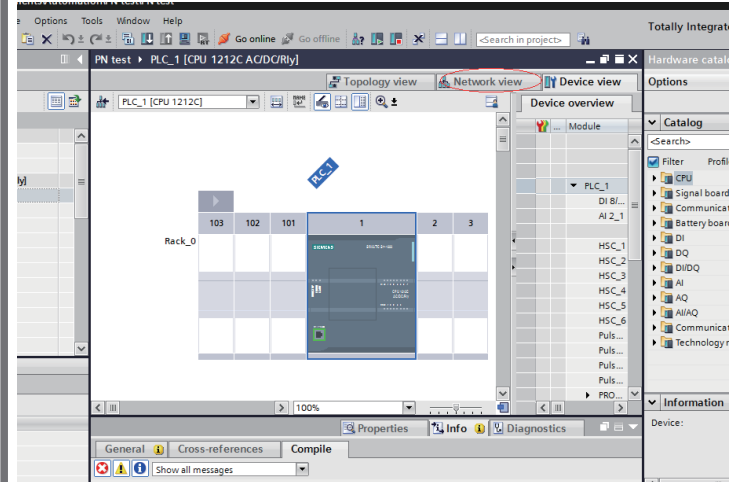

Select the Ethernet interface of the PLC, and choose **Properties > General**.

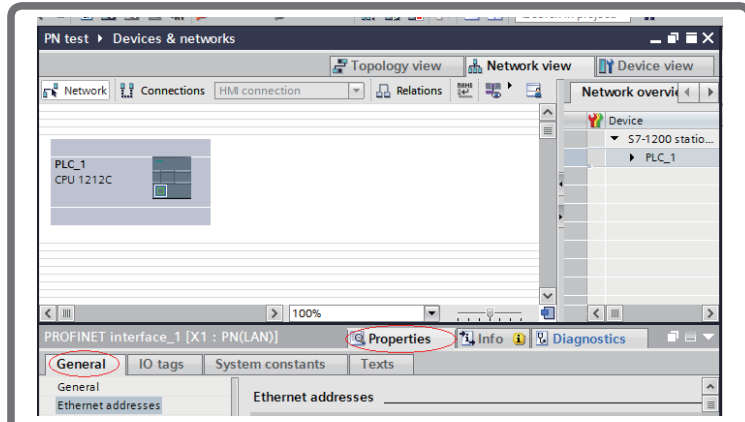

Set the IP address and subnet mask of the PLC, and click **Add new subnet**.

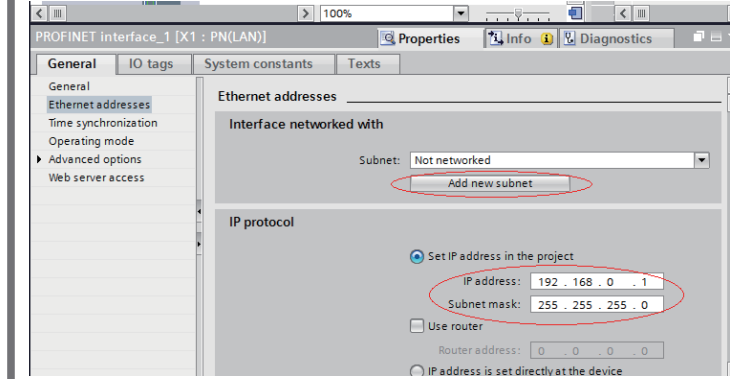

Locate MD500 under **Hardware catalog** on the right, and double-click **MD500PN**.

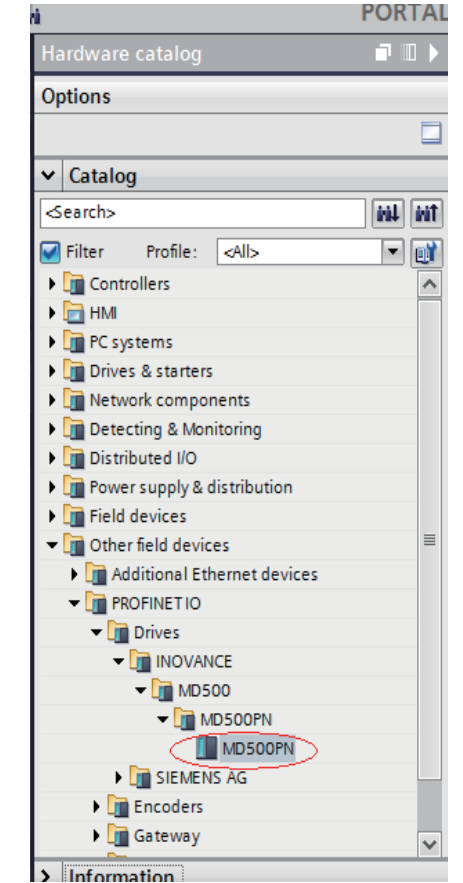

Click **Not assigned** to select the master station system for the slave.

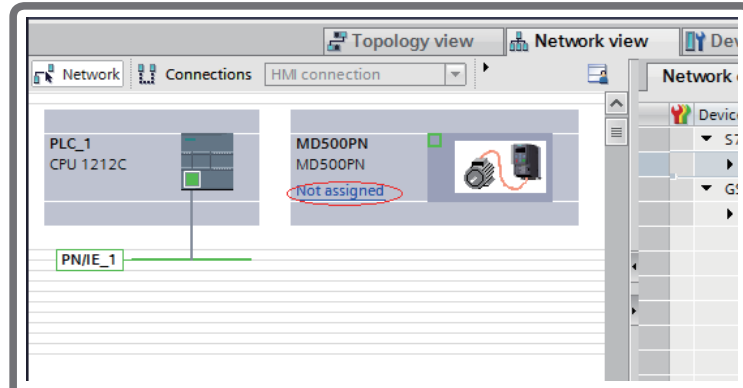

Select the slave station, and choose **Properties > General**. Then, choose **PROFINET interface [X1] > Ethernet addresses** and set the IP address.

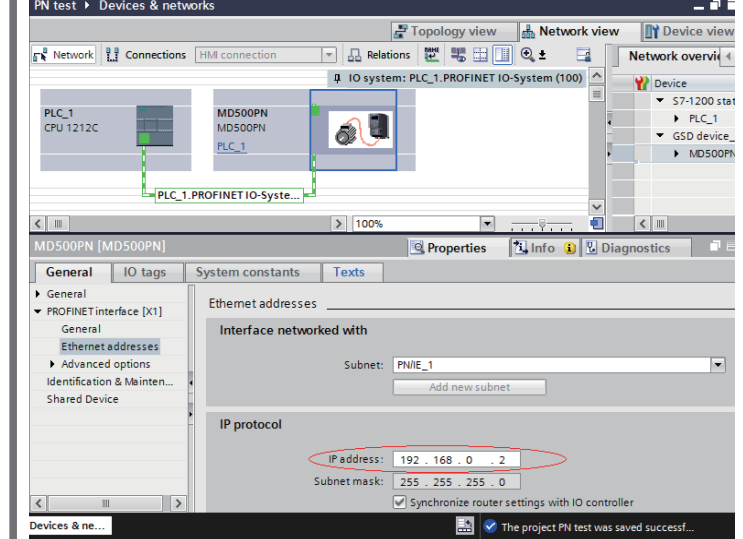

Scroll down the screen to locate **PROFINET**. Deselect **Generate PROFINET device name automatically** and enter a name for **PROFINET device name**. (Or you can keep the option selected to have the system generate a device name automatically.)

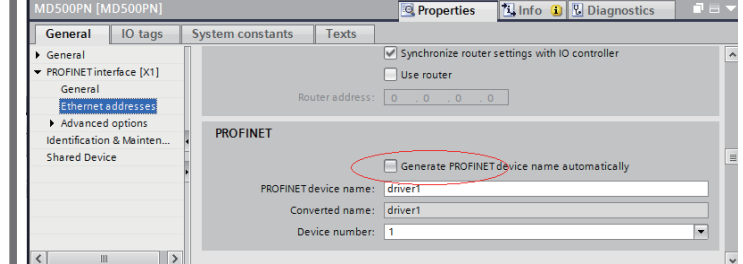

Step 4: Configure data features of the slave station.

Select the slave station and switch to the **Device view** page. Locate **Module** under **Hardware catalog**, and double-click the data length for the slave station as required.

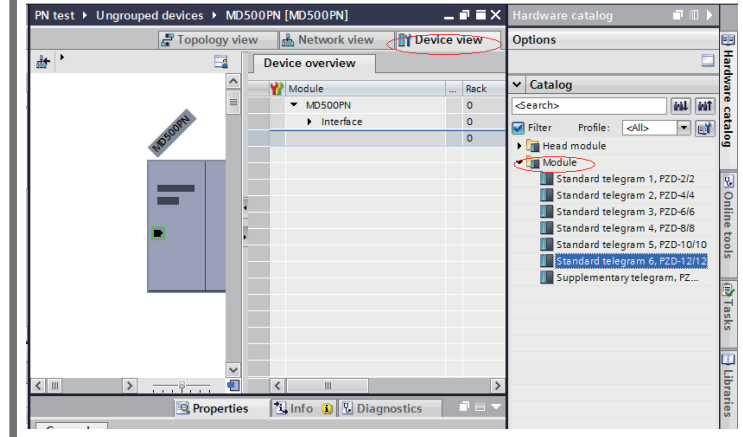

Step 5: Configure the PZD.

The fixed configuration of PZD1 and PZD2 cannot be modified by users. PZD3 to PZD12 are for customized periodic data exchange. They can be set in hardware configuration.

After completing step 4, select the message format, choose **Properties > General**,

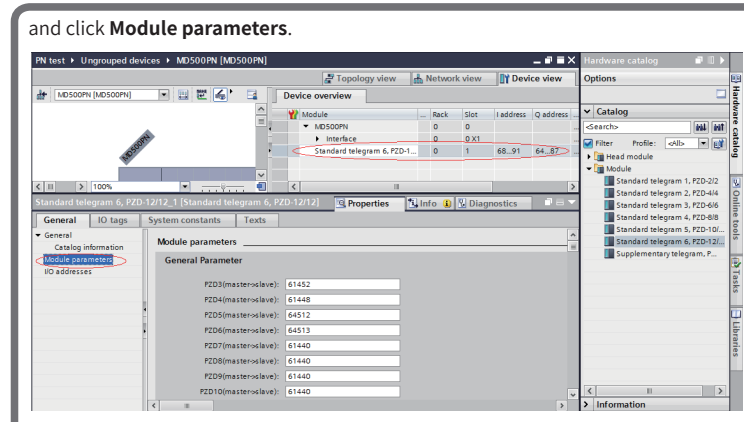

**PZDx(master->slave)** indicates the address used by the master station to write the slave station, and **PZDx(slave->master)** indicates the address used by the master station to read the slave station. **PZD3 to PZD12** (determined by the selected message type) displayed in decimal are available. For example, to set **PZD3(master->slave)** to **F0-12**, enter **61452**.

By default, all PZDs of MD500 are set to **F0-00** (61440 in decimal). For unused PZDs, modification is not required and default values can be retained. PZD mapping relationships must be set independently for each slave station as required (if mapping relationships of various slave stations are the same, you can select one configured slave station, press **Ctrl+C**, select the PROFINET bus in the configuration, press **Ctrl+V**, and modify the device name and IP address).

Switch to **Network view**. If more stations need to be added, repeat the preceding steps. If the configuration is the same, select and copy a configured slave and modify the IP address and device name (note that a different device name is required).

Step 6: Download the configuration.

Save the network configuration. Set the IP address of the PC to the same network segment with the PLC. (Note that the IP address of the PC must be different from the IP addresses of the slave stations in the configuration. Automatic IP address distribution is also allowed for the PC.) Then, start compiling, click **Load**, select the interface, and click **Start search**.

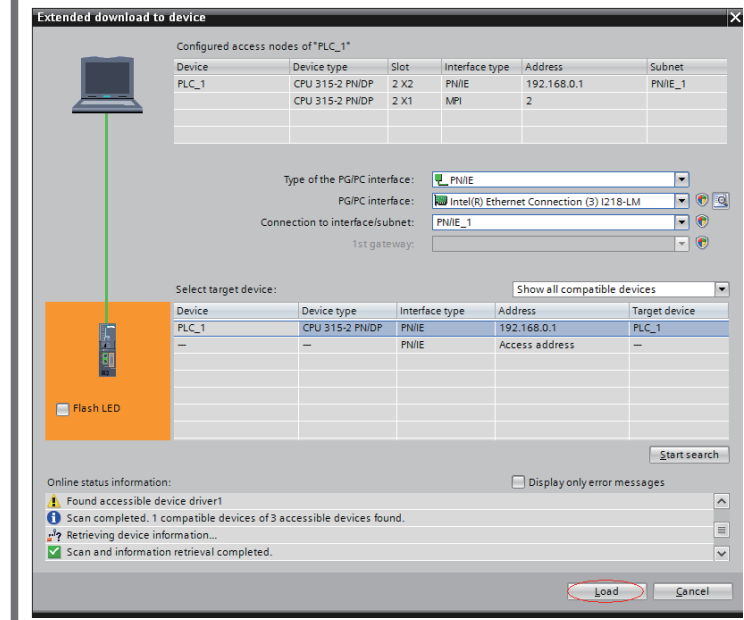

Step 7: Assign device names.

After completing step 6, assign device names to slave stations without names. Select a slave station, and choose **Online > Assign device name** (or right-click on the selected slave station and choose **Assign device name** in the shortcut menu).

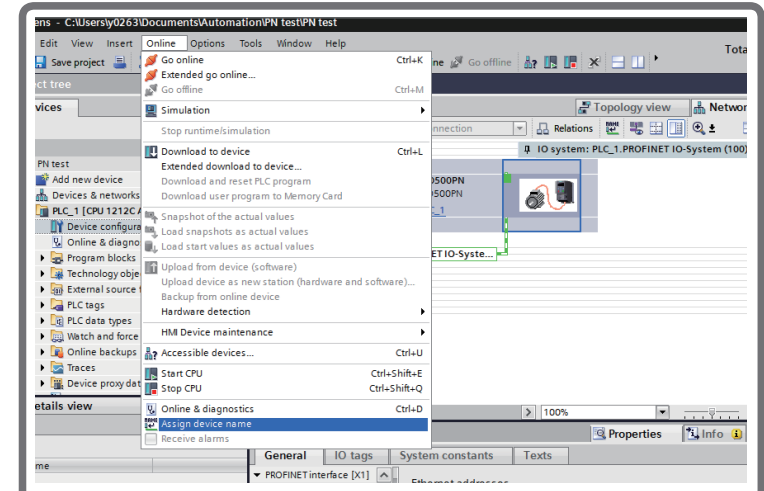

On the displayed page, devices of the same type are listed. Select the slave station to be assigned the device name to based on its unique MAC address. The MAC address of the MD500-PN1 card can be found on its housing. Then, click **Assign name**.

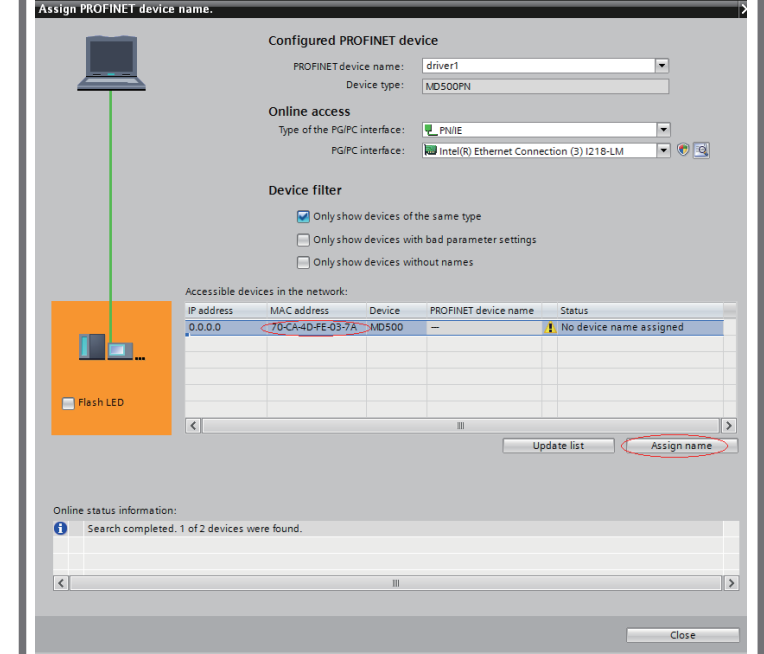

If information similar to the following figure is displayed, the device name is assigned successfully. The displayed PROFINET device name in the following figure must be consistent with that displayed in the preceding figure. After assigning the device name, close the window or select another device for **PROFINET device name** to assign device names to other stations.

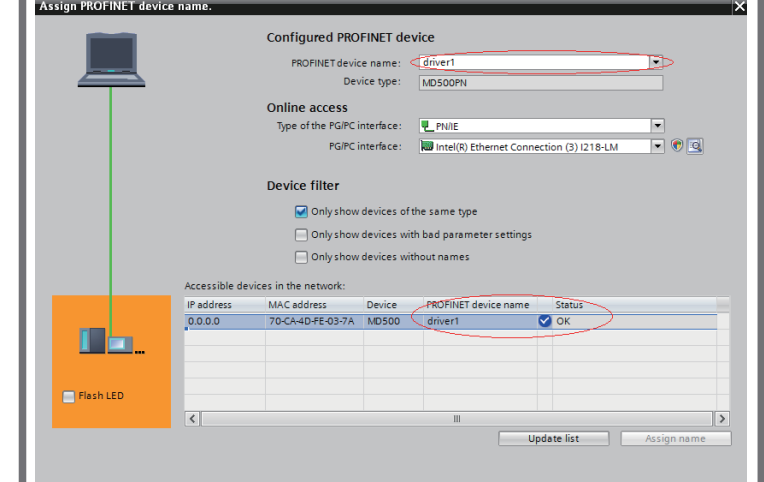

The slave station will save the assigned name after receiving it. The master station identifies each slave station based on the device name. (A device name is bound with the MAC address during device name assignment since the MAC address is inconvenient for usage.)

Note:

- 1) Each device name can be assigned to only one slave station in the network.



- 2) After modifying the device name of a station in the configuration, the operations for name assignment must be performed again. (For any exception, see "4. Troubleshooting".)
- 3) After modifying an IP address, download the modified configuration to the PLC to validate it. Name assignment is not required.

After all the preceding operations are complete, the PROFINET slave station is configured. Now, you can compile programs in the PLC to control the AC drive. Slave read/write operations on the PLC are similar to those of PROFIBUS-DP.

### MRP function of the MD500-PN1 card

MRP indicates Media Redundancy Protocol. The MRP ring network is used in PROFINET to enable the MRP function. Only one MRP ring network is allowed in one PROFINET network.

The MD500-PN1 card whose software version is 1.04 or above supports the MRP function. (Check U0-67 on the AC drive to see the version.)

To use the MRP function, the corresponding configuration is required.

#### Configuring the MRP function in PORTAL

Step 1: Configure the MRP manager.

An MRP manager is required in the MRP ring network. The MD500-PN1 card cannot be used as the manager. Generally, the PLC is used as the manager. Select the station to be used as the manager, and select **Manager (auto)** for **Media redundancy role**, as shown in the following figure.

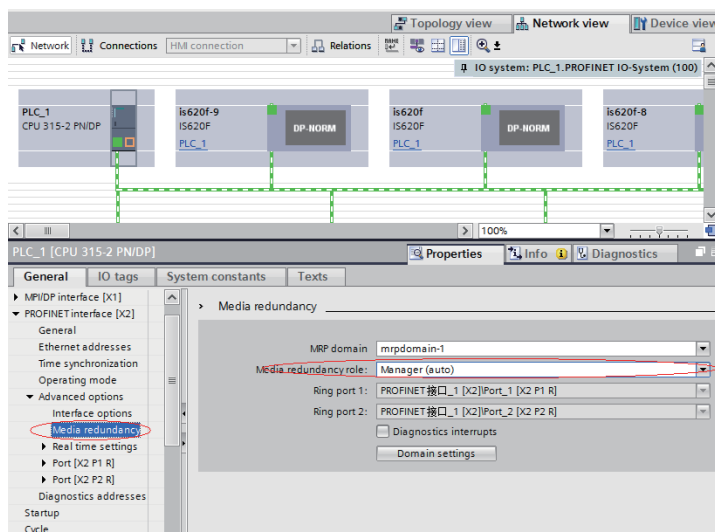

Step 2: Configure the MRP client.

Select the slave station, and select **Client** for **Media redundancy role**, as shown in the following figure. Note that the manager must be configured before the client is configured.

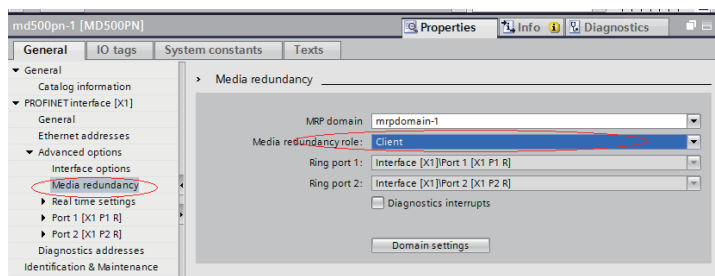

Step 3: Download the configuration.

After configuring all devices in the MRP ring network, start compiling and download the configuration to the PLC.

#### Configuring the MRP function in STEP 7

Step 1: Configure the MRP manager.

An MRP manager is required in the MRP ring network. The MD500-PN1 card cannot be used as the manager. Generally, the PLC is used as the manager.

Double-click PN-IO of the PLC, and select **Manager (auto)** for **Role** in the **Media Redundancy** tab, as shown in the following figure.

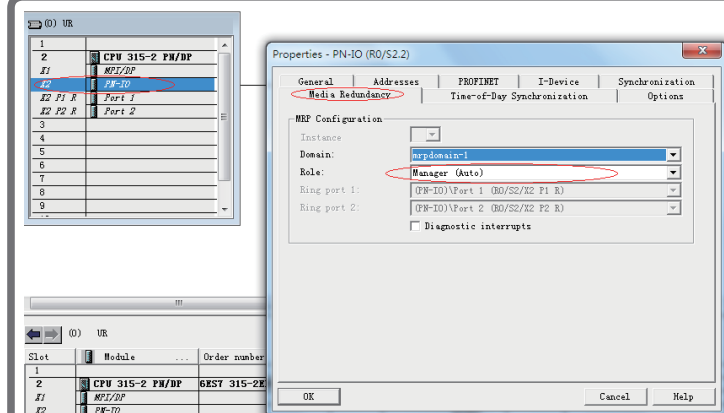

Step 2: Configure the MRP client.

Select the slave station, double-click **Interface**, and select **Client** for **Role** in the **Media Redundancy** tab, as shown in the following figure. Note that the manager must be configured before the client is configured.

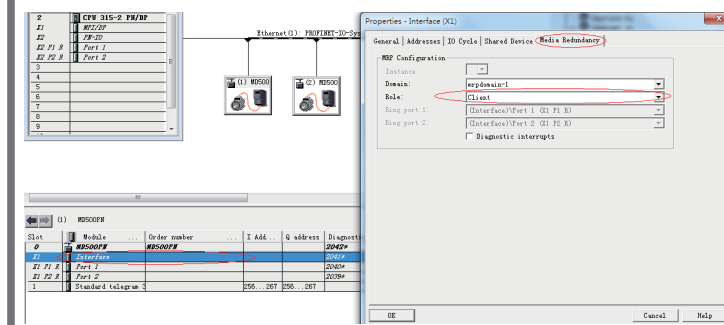

Step 3: Download the configuration.

After configuring all devices in the MRP ring network, start compiling and download the configuration to the PLC.

Note:

- 1) All devices in the ring network must be configured as the MRP manager or client.
- 2) The topological structure configuration is not required during MRP configuration. If topological structure configuration is required, perform it after the MRP configuration is complete.
- 3) Do not use the ring network for devices without the MRP function configured. Otherwise, connection failure or frequent disconnections will occur.
- 4) For the PROFINET network configured with the MRP, when a disconnection occurs in the ring network, handshaking will be performed again. In this case, the AC drive slave station reports ERR16 and automatically clears it (if the automatic clearing function is supported) after the handshaking is complete, or you can manually clear it. After the network recovers from the disconnection, the preceding operations are repeated.
- 5) Even though the MRP is configured, when two disconnections occur in the network, all nodes between the two disconnected points cannot be connected normally. To avoid such problems, the star network is recommended.

## 4. Troubleshooting

The MD500-PN1 card can be replaced directly when a slave node is faulty without performing device configuration again.

Prerequisites for directly replacing the MD500-PN1 card:

- 1) The alternative component and the component to be replaced are both the MD500-PN1 cards.
- 2) The alternative MD500-PN1 card has not been assigned a device name to before.
- 3) The topology has been configured during PLC network configuration.
- 4) The **Support device replacement without exchangeable medium** option is enabled during PLC configuration.

To directly replace the MD500-PN1 card, the corresponding configuration is required. The configuration varies in STEP 7 and PORTAL.

#### Enabling the Support device replacement without exchangeable medium option and setting topology in PORTAL

Open PORTAL, and select the PROFINET interface of the master station in the hardware configuration. In the **Properties > General** tab, choose **Advanced options > Interface options**, and select **Support device replacement without exchangeable medium**, as shown in the following figure.

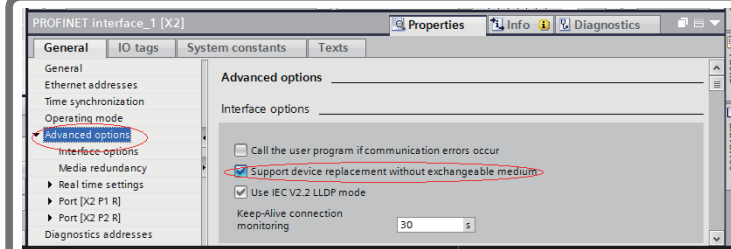

For the S7-1200 or S7-1500 PLC, the suboption **Permit overwriting of device names of all assigned IO devices** is provided. If this suboption is selected, the second prerequisite for directly replacing the MD500-PN1 card is not required.

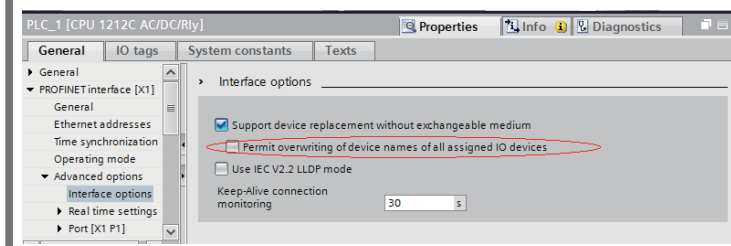

Then, switch to **Topology view**, as shown in the following figure.

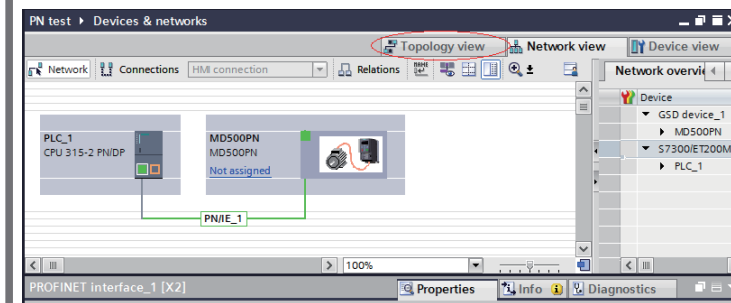

In the topology view, click and drag the interface to the interface of another device which is directly connected with the interface, and release the mouse button.

Note that the preceding connection must be consistent with the actual network connection of devices. For example, if P1 of the PLC is connected to P2 of slave station 1, and P1 of slave station 1 is connected to another slave station, the connections must be consistent in the topology. An incorrect topology will cause function failure after replacement and even communication errors. (After the MD500-PN1 card is installed, P1 is on the left and P2 is on the right when facing to the RJ45 interface.)

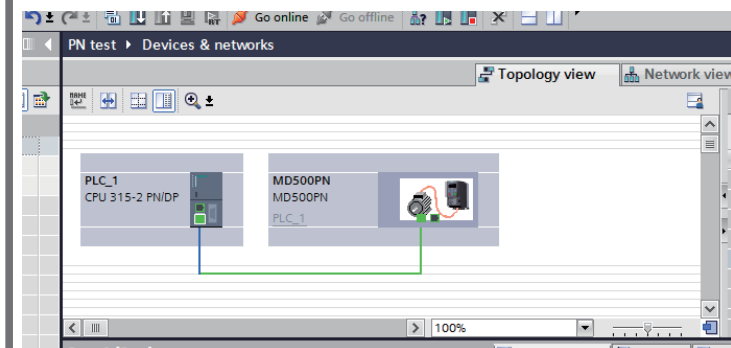

After completing the topology, start compiling and download it to the PLC.

#### Enabling the Support device replacement without exchangeable medium option and setting topology in STEP 7

In hardware configuration, double-click **PN-IO**, as shown in the following figure.

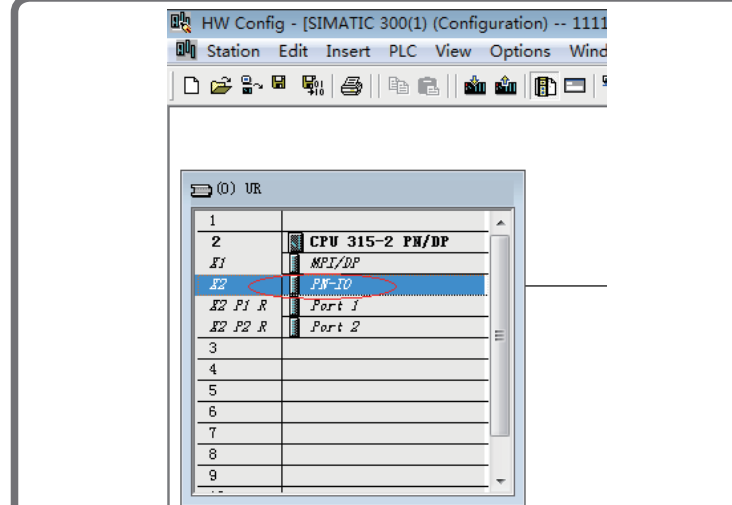

In the **General** tab, select **Support device replacement without exchangeable medium**, and click **OK**, as shown in the following figure.

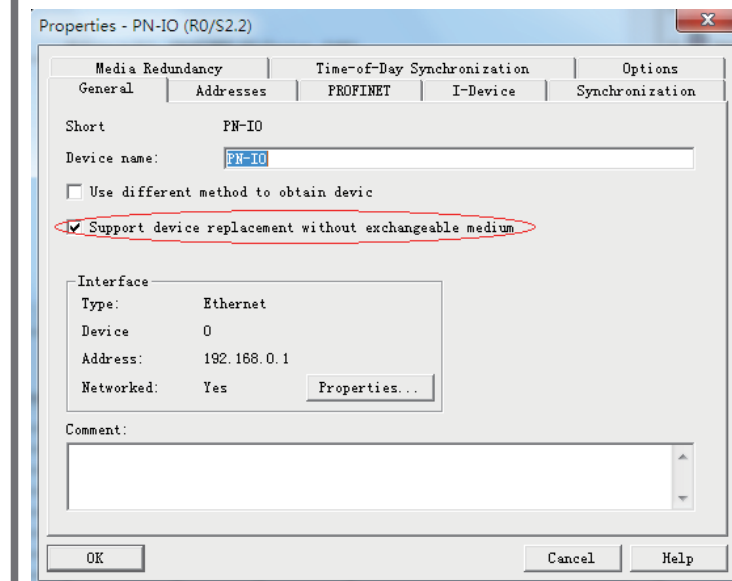

According to the actual network connections, double-click **Port 1** or **Port 2** of the PLC, and switch to the **Topology** tab. Select the port of the slave station connected to the PLC for **Partner port** (the default option is **Any partner**, which must be changed to the actual connected port), and click **OK**.

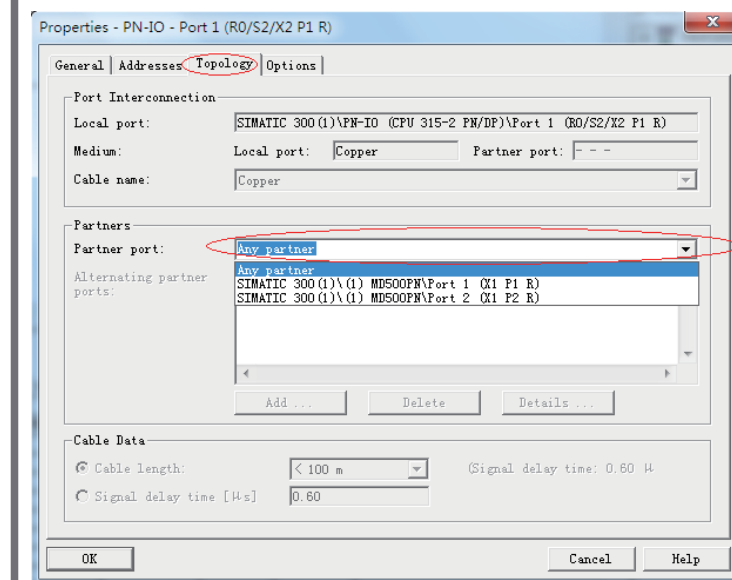

Then, click the corresponding ports of the slave station to set the topology. The operations are similar to the preceding steps. After setting all connected ports, start compiling and download the configuration to the PLC.

After completing the preceding configuration, perform the following operations when any slave station device requires replacement:

- 1) Disconnect the device from the network.
- 2) Install a new device to which no device name is assigned before at the same

position. (For S7-1200 or S7-1500, if **Permit overwriting of device names of all assigned IO devices** has been selected, devices which have been assigned names to can be used.)

- 3) Connect the new device to the network using the original wiring mode. (Note that the network cable connection must be consistent with the original connection and the connection in the topology.)
- 4) Power on the slave station to have the PLC assign a device name to the newly connected device automatically.

## INOVANCE Warranty Agreement

- 1) Inovance provides an 18-month free warranty to the equipment itself from the date of manufacturing (subject to the information indicated by the barcode on the product) for the failure or damage under normal use conditions.
- 2) Within the warranty period, maintenance will be charged for the damage caused by the following reasons:
  - a. Improper use or disassembly/repair/modification without prior permission
  - b. Fire, flood, abnormal voltage, natural disasters, and secondary disasters
  - c. Hardware damage caused by dropping or transportation after procurement
  - d. Operations not following the user instructions
  - e. Damage out of the equipment (for example, external device factors)
- 3) The maintenance fee is charged according to the latest Maintenance Price List of Inovance.
- 4) If there is any problem during the service, contact Inovance's agent or Inovance directly.
- 5) You are assumed to agree on terms and conditions of this warranty agreement by purchase of the product. Inovance reserves the rights for explanation of this agreement.

Suzhou Inovance Technology Co., Ltd.

Address: No.16, Youxiang Road, Yuexi Town, Wuzhong District, Suzhou 215104, P.R. China

Website: <http://www.inovance.com>