



MD500-PLUS Series General-Purpose AC Drive Commissioning Guide



Industrial
Automation



Intelligent
Elevator



New Energy
Vehicle



Industrial
Robot



Rail
Transit



Data code 19011579 A04

Preface

Introduction

The MD500-PLUS series AC drive is a general-purpose high-performance current vector control AC drive designed to control and regulate the speed and torque of three-phase AC asynchronous motors and permanent magnet synchronous motors. It can be used to drive textile machines, paper machines, wire drawing machines, machine tools, packaging machines, food machines, fans, water pumps, and other automated production equipment.

This guide describes the commissioning and trial run of the AC drive, covering software tools, processes, and specific operations.

More Documents

Document Name	Data Code	Description
MD500-PLUS Series General-Purpose AC Drive Quick Installation and Commissioning Guide	19011581	Describes the installation, wiring, commissioning, troubleshooting, parameters, and fault codes of the AC drive.
MD500-PLUS Series General-Purpose AC Drive Hardware Guide	19011578	Describes the composition, technical specifications, components, dimensions, options (including installation accessories, cables, and peripheral electrical components), and extension cards of the MD500-PLUS series AC drive, as well as routine maintenance and repair, and certifications and standards of the AC drive.
MD500-PLUS Series General-Purpose AC Drive Installation Guide	19011582	Describes the installation dimensions, space design, specific installation steps, wiring requirements, routing requirements, and option installation requirements of the AC drive, as well as common EMC problem solving recommendations.
MD500-PLUS Series General-Purpose AC Drive Software Guide	19011580	Describes the function application, communication, fault codes, and parameters of the AC drive.

Revision History

Date	Version	Description
September 2021	A04	Corrected errors.
November 2020	A01	Corrected errors.
July 2020	A00	First release.

Document Acquisition

This guide is not delivered with the AC drive. You can obtain the PDF version of this document using the following method:

Log in to Inovance's website (<http://en.inovance.cn/>), choose **Support > Download**, perform keyword search, and download the PDF file.

Table of Contents

Preface	1
Fundamental Safety Instructions	5
1 Software Tools	11
1.1 LED Operating Panel	11
1.1.1 LED Operating Panel	11
1.1.2 Parameters	16
1.1.3 Setting Parameters	19
1.1.4 Viewing Parameters	21
1.1.5 Viewing Status Parameters	21
1.1.6 Viewing Faults	21
1.1.7 Operating the MF.K Key	22
1.1.8 Driving the Motor Using the Operating Panel	23
2 Commissioning and Trial Run	28
2.1 Commissioning Process	28
2.1.1 Basic Commissioning Process	28
2.1.2 Commissioning Process in V/f Control Mode	30
2.1.3 Commissioning Process in SVC/FVC Mode	31
2.1.4 Commissioning Process in PMVC Mode	32
2.2 Commissioning Procedure	32
2.2.1 Checklist Before Power-on	32
2.2.2 Powering on the AC Drive	33
2.2.3 Initializing Parameters	34
2.2.4 Checking Software Versions	35
2.2.5 Setting Motor Parameters	35
2.2.6 Performing Auto-tuning on Motor Parameters	37
2.2.7 Selecting a Command Source	40
2.2.8 Selecting a Frequency Source	41
2.2.9 Setting the Control Mode	43
2.2.10 Setting V/f Parameters (Optional)	44
2.2.11 Setting SVC Parameters (Optional)	45
2.2.12 Setting FVC Parameters (Optional)	46
2.2.13 Setting PMVC Parameters (Optional)	49
2.2.14 Setting the Acceleration/Deceleration Time	51
2.2.15 Setting the Startup Mode (Optional)	52
2.2.16 Setting the Startup Frequency (Optional)	53
2.2.17 Setting the S-curve (Optional)	53
2.2.18 Setting Stop Parameters	54
2.2.19 Setting AI (Optional)	55
2.2.20 Setting AO (Optional)	56
2.2.21 Setting DI (Optional)	58
2.2.22 Setting DO (Optional)	64

2.2.23	Setting Multi-speed References (Optional)	69
2.2.24	Setting Relay Output (Optional)	70
2.3	Function Commissioning	76
2.3.1	PMVC Function Commissioning (Applicable Only to Synchronous Motors)	76
3	Troubleshooting	79
3.1	Common Faults and Diagnosis	79
3.1.1	Display of Alarms and Faults	79
3.1.2	Restart upon Faults	80
3.1.3	Common Troubleshooting	81
3.1.4	Troubleshooting During Trial Run in Different Control Modes	83
3.2	List of Fault Codes	86
4	Parameters	97
4.1	List of Function Parameters	97
4.2	List of Monitoring Parameters	166

Fundamental Safety Instructions

Safety Precautions

1. This chapter presents essential safety instructions for a proper use of the equipment. Before operating the equipment, read through the guide and comprehend all the safety instructions. Failure to comply with the safety instructions may result in death, severe personal injuries, or equipment damage.
2. "CAUTION", "WARNING", and "DANGER" items in the guide only indicate some of the precautions that need to be followed; they just supplement the safety precautions.
3. Use this equipment according to the designated environment requirements. Damage caused by improper use is not covered by warranty.
4. Inovance shall take no responsibility for any personal injuries or property damage caused by improper use.

Safety Levels and Definitions



DANGER

Indicates that failure to comply with the notice will result in death or severe personal injuries.



WARNING

Indicates that failure to comply with the notice may result in death or severe personal injuries.



CAUTION

Indicates that failure to comply with the notice may result in minor or moderate personal injuries or equipment damage.

General Safety Instructions

- Drawings in the guide are sometimes shown without covers or protective guards. Remember to install the covers or protective guards as specified first, and then perform operations in accordance with the instructions.
- The drawings in the guide are shown for illustration only and may be different from the product you purchased.

Unpacking



WARNING

- Do not install the equipment if you find damage, rust, or signs of use on the equipment or accessories upon unpacking.
- Do not install the equipment if you find water seepage or missing or damaged components upon unpacking.
- Do not install the equipment if you find the packing list does not conform to the equipment you received.

 CAUTION

- Check whether the packing is intact and whether there is damage, water seepage, dampness, and deformation before unpacking.
- Unpack the package by following the unpacking sequence. Do not strike the package violently.
- Check whether there is damage, rust, or injuries on the surface of the equipment and equipment accessories before unpacking.
- Check whether the package contents are consistent with the packing list before unpacking.

Storage and Transportation

 WARNING

- Large-scale or heavy equipment must be transported by qualified professionals using specialized hoisting equipment. Failure to comply may result in personal injuries or equipment damage.
- Before hoisting the equipment, ensure the equipment components such as the front cover and terminal blocks are secured firmly with screws. Loosely-connected components may fall off and result in personal injuries or equipment damage.
- Never stand or stay below the equipment when the equipment is being hoisted by the hoisting equipment.
- When hoisting the equipment with a steel rope, ensure the equipment is hoisted at a constant speed without suffering from vibration or shock. Do not turn the equipment over or let the equipment stay hanging in the air. Failure to comply may result in personal injuries or equipment damage.

 CAUTION

- Handle the equipment with care during transportation and mind your steps to prevent personal injuries or equipment damage.
- When carrying the equipment with bare hands, hold the equipment casing firmly with care to prevent parts from falling. Failure to comply may result in personal injuries.
- Store and transport the equipment based on the storage and transportation requirements. Failure to comply will result in equipment damage.
- Avoid storing or transporting the equipment in environments with water splash, rain, direct sunlight, strong electric field, strong magnetic field, and strong vibration.
- Avoid storing the equipment for more than three months. Long-term storage requires stricter protection and necessary inspections.
- Pack the equipment strictly before transportation. Use a sealed box for long-distance transportation.
- Never transport the equipment with other equipment or materials that may harm or have negative impacts on this equipment.

Installation

 DANGER

- The equipment must be operated only by professionals with electrical knowledge.

 **WARNING**





- Read through the guide and safety instructions before installation.
- Do not install this equipment in places with strong electric or magnetic fields.
- Before installation, check that the mechanical strength of the installation site can bear the weight of the equipment. Failure to comply will result in mechanical hazards.
- Do not wear loose clothes or accessories during installation. Failure to comply may result in an electric shock.
- When installing the equipment in a closed environment (such as a cabinet or casing), use a cooling device (such as a fan or air conditioner) to cool the environment down to the required temperature. Failure to comply may result in equipment over-temperature or a fire.
- Do not retrofit the equipment.
- Do not fiddle with the bolts used to fix equipment components or the bolts marked in red.
- When the equipment is installed in a cabinet or final assembly, a fireproof enclosure providing both electrical and mechanical protections must be provided. The IP rating must meet IEC standards and local laws and regulations.
- Before installing devices with strong electromagnetic interference, such as a transformer, install a shielding device for the equipment to prevent malfunction.
- Install the equipment onto an incombustible object such as a metal. Keep the equipment away from combustible objects. Failure to comply will result in a fire.





 **CAUTION**

- Cover the top of the equipment with a piece of cloth or paper during installation. This is to prevent unwanted objects such as metal shavings, oil, and water from falling into the equipment and causing faults. After installation, remove the cloth or paper on the top of the equipment to prevent over-temperature caused by poor ventilation due to blocked ventilation holes.
- Resonance may occur when the equipment operating at a constant speed executes variable speed operations. In this case, install the vibration-proof rubber under the motor frame or use the vibration suppression function to reduce resonance.

Wiring **DANGER**

- Equipment installation, wiring, maintenance, inspection, or parts replacement must be performed only by professionals.
- Before wiring, cut off all the power supplies of the equipment, and wait for at least the time designated on the equipment warning label before further operations because residual voltage still exists after power-off. After waiting for the designated time, measure the DC voltage in the main circuit to ensure the DC voltage is within the safe voltage range. Failure to comply will result in an electric shock.
- Do not perform wiring, remove the equipment cover, or touch the circuit board with power ON. Failure to comply will result in an electric shock.
- Check that the equipment is grounded properly. Failure to comply will result in an electric shock.



 WARNING <ul style="list-style-type: none">• Do not connect the input power supply to the output end of the equipment. Failure to comply will result in equipment damage or even a fire.• When connecting a drive to the motor, check that the phase sequences of the drive and motor terminals are consistent to prevent reverse motor rotation.• Cables used for wiring must meet cross sectional area and shielding requirements. The shield of the cable must be reliably grounded at one end.• Fix the terminal screws with the tightening torque specified in the user guide. Improper tightening torque may overheat or damage the connecting part, resulting in a fire.• After wiring is done, check that all cables are connected properly and no screws, washers or exposed cables are left inside the equipment. Failure to comply may result in an electric shock or equipment damage.
 CAUTION <ul style="list-style-type: none">• During wiring, follow the proper electrostatic discharge (ESD) procedure, and wear an antistatic wrist strap. Failure to comply will damage the equipment or the internal circuits of the equipment.• Use shielded twisted pairs for the control circuit. Connect the shield to the grounding terminal of the equipment for grounding purpose. Failure to comply will result in equipment malfunction.
Power-on
 DANGER <ul style="list-style-type: none">• Before power-on, check that the equipment is installed properly with reliable wiring and the motor can be restarted.• Check that the power supply meets equipment requirements before power-on to prevent equipment damage or a fire.• After power-on, do not open the cabinet door or protective cover of the equipment, touch any terminal, or disassemble any unit or component of the equipment. Failure to comply will result in an electric shock.
 WARNING <ul style="list-style-type: none">• Perform a trial run after wiring and parameter setting to ensure the equipment operates safely. Failure to comply may result in personal injuries or equipment damage.• Before power-on, check that the rated voltage of the equipment is consistent with that of the power supply. Failure to comply may result in a fire.• Before power-on, check that no one is near the equipment, motor, or machine. Failure to comply may result in death or personal injuries.
Operation
 DANGER <ul style="list-style-type: none">• The equipment must be operated only by professionals. Failure to comply will result in death or personal injuries.• Do not touch any connecting terminals or disassemble any unit or component of the equipment during operation. Failure to comply will result in an electric shock.

 WARNING
<ul style="list-style-type: none">• Do not touch the equipment casing, fan, or resistor with bare hands to feel the temperature. Failure to comply may result in personal injuries.• Prevent metal or other objects from falling into the equipment during operation. Failure to comply may result in a fire or equipment damage.
Maintenance
 DANGER
<ul style="list-style-type: none">• Equipment installation, wiring, maintenance, inspection, or parts replacement must be performed only by professionals.• Do not maintain the equipment with power ON. Failure to comply will result in an electric shock.• Before maintenance, cut off all the power supplies of the equipment and wait for at least the time designated on the equipment warning label.• In case of a permanent magnet motor, do not touch the motor terminals immediately after power-off because the motor terminals will generate induced voltage during rotation even after the equipment power supply is off. Failure to comply will result in an electric shock.
 WARNING
<ul style="list-style-type: none">• Perform routine and periodic inspection and maintenance on the equipment according to maintenance requirements and keep a maintenance record.
Repair
 DANGER
<ul style="list-style-type: none">• Equipment installation, wiring, maintenance, inspection, or parts replacement must be performed only by professionals.• Do not repair the equipment with power ON. Failure to comply will result in an electric shock.• Before inspection and repair, cut off all the power supplies of the equipment and wait for at least the time designated on the equipment warning label.
 WARNING
<ul style="list-style-type: none">• When the fuse is blown or the circuit breaker or earth leakage current breaker (ELCB) trips, wait for at least the time designated on the equipment warning label before power-on or further operations. Failure to comply may result in death, personal injuries or equipment damage.• When the equipment is faulty or damaged, the troubleshooting and repair work must be performed by professionals that follow the repair instructions, with repair records kept properly.• Replace quick-wear parts of the equipment according to the replacement instructions.• Do not use damaged equipment. Failure to comply may result in death, personal injuries, or severe equipment damage.• After the equipment is replaced, check the wiring and set parameters again.

Disposal
 WARNING <ul style="list-style-type: none"> • Dispose of retired equipment in accordance with local regulations and standards. Failure to comply may result in property damage, personal injuries, or even death. • Recycle retired equipment by observing industry waste disposal standards to avoid environmental pollution.

Safety Labels

For safe equipment operation and maintenance, comply with the safety labels on the equipment. Do not damage or remove the safety labels. See the following table for descriptions of the safety labels.

Safety Signs		Description
T1 to T12 models		<ul style="list-style-type: none"> • Read through the safety instructions before operating the equipment. Failure to comply may result in equipment damage, personal injuries, or even death. • Do not touch terminals or remove the cover while the power is on or within 10 minutes after the power is turned off. Failure to comply may result in an electric shock.
T13 models		<ul style="list-style-type: none"> • Read through the safety instructions before operating the equipment. Failure to comply may result in equipment damage, personal injuries, or even death. • Do not touch terminals or remove the cover while the power is on or within 15 minutes after the power is turned off. Failure to comply may result in an electric shock.

1 Software Tools

1.1 LED Operating Panel

1.1.1 LED Operating Panel

Dimensions

The following figure shows the appearance and installation dimensions of the LED operating panel.

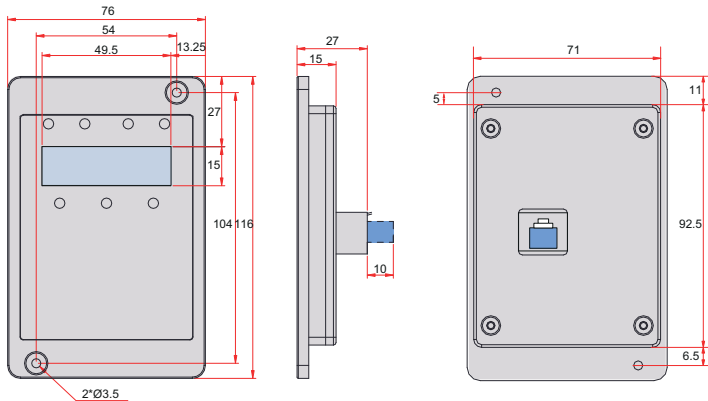

Figure 1-1 Appearance and installation dimensions of the LED operating panel (unit: mm)

Components

You can use the LED operating panel that displays the status of the AC drive to set parameters and view fault information. The following figure shows the components of the operating panel.

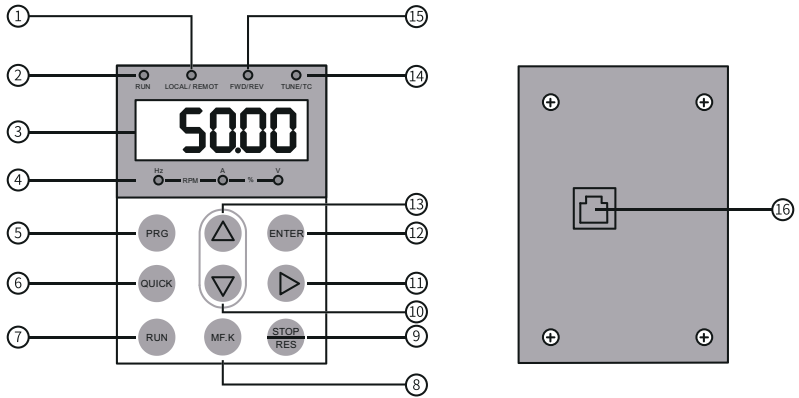

Figure 1-2 Components of the operating panel







Table 1-1 Components of the operating panel

No.	Component Name	No.	Component Name
1	Command source indicator	9	STOP/RES key
2	RUN indicator	10	Decrement key
3	Data display area	11	Shift key
4	Parameter unit indicator	12	Confirm key
5	Programming key	13	Increment key
6	Menu key	14	Auto-tuning/Torque control/ Fault indicator
7	RUN key	15	Running direction indicator
8	Multi-function key	16	RJ45 port (for connecting an external operating panel)

Keys

Table 1-2 Keys of the operating panel

Key	Name	Function
	Programming key	Used to return to the previous screen or go to a level I menu.
	ENTER key	Used to access the next screen or confirm a mode, a parameter, or a reference value.

Key	Name	Function
	UPkey	Used to increase the parameter number/ reference value.
	DOWN key	Used to decrease the parameter number/ reference value.
	SHIFT key	Used to shift the display of parameters cyclically leftward and select the digit to be modified during parameter number/value setting.
	RUN key	Used to start the AC drive in operating panel control mode.
	STOP/RES key	Used to stop present operation or reset the AC drive upon a fault.
	Multi-function key	Used to switch between functions as defined by the value of F7-01.
	Menu key	Used to switch over between menu modes as defined by the value of FP-03.

Status indicators























In the following table,  indicates that the indicator is on,  indicates that the indicator is off, and  indicates the indicator blinks.

Table 1-3 Indicators on the operating panel

Indicator Status		Description
RUN RUN indicator	 RUN	Off: stop
	 RUN	On: running
LOCAL/REMOT Command source indicator	 LOCAL/ REMOT	Off: operating panel control
	 LOCAL/ REMOT	On: terminal control
	 LOCAL/ REMOT	Blinking: communication control
FWD/REV Running direction indicator	 FWD/REV	Off: forward running
	 FWD/REV	On: reverse running
TUNE/TC Auto-tuning/Torque control/Fault indicator	 TUNE/ TC	Off: normal running
	 TUNE/ TC	On: torque control active
	 TUNE/ TC	Blinking slowly: auto-tuning (once per second)
	 TUNE/ TC	Blinking quickly: faulty (four times per second)
 Hz — RPM —  A — % —  V	Frequency unit: Hz	
 Hz — RPM —  A — % —  V	Current unit: A	
 Hz — RPM —  A — % —  V	Voltage unit: V	

Indicator Status	Description
	Speed unit: RPM
	Percentage (%)

Data display

The five-digit LED data display indicates the frequency reference, output frequency, monitoring information, and fault code.



Table 1-4 Description of LED display

LED Display	Actual Data	LED Display	Actual Data	LED Display	Actual Data	LED Display	Actual Data
0	0	6	6	C	C	n	N
1	1	7	7	c	c	p	P
2	2	8	8	d	D	r	R
3	3	9	9	E	E	r	T
4	4	A	A	F	F	u	u
5	5, S	b	B	L	L	U	U

1.1.2 Parameters

Table 1-5 Parameters related to the operating panel

Para. No.	Name	Default	Value Range	Description
F7-01	MF.K key function selection	0	<p>0: MF.K key disabled</p> <p>1: Switchover between operating panel control and remote control (terminal I/O control or communication control)</p> <p>2: Switchover between forward and reverse run</p> <p>3: Forward jog</p> <p>4: Reverse jog</p>	<p>This parameter is used for setting the function of the MF.K key on the operating panel.</p> <p>0: MF.K key disabled The key has no function.</p> <p>1: Switchover between operating panel control and remote control (terminal I/O control or communication control)</p> <p>When F0-02 is set to 0 (operating panel control), pressing the MF.K key produces no effect. When F0-02 is set to 1 (terminal I/O control), pressing the MF.K key can switch between terminal I/O control and operating panel control. When F0-02 is set to 2 (communication control), pressing the MF.K key can switch between communication control and operating panel control.</p> <p>2: Switchover between forward and reverse run Pressing the MF.K key can switch between frequency reference directions. This function is available only when the operating panel is selected as the command source.</p> <p>3: Forward jog Pressing the MF.K key enables forward jog (FJOG). This function is available only when the operating panel is selected as the command source.</p> <p>4: Reverse jog Pressing the MF.K key enables reverse jog (RJOG). This function is available only when the operating panel is selected as the command source.</p>
F7-02	STOP/RES key function	0	<p>0: STOP/RES key enabled only in operating panel control mode</p> <p>1: STOP/RES key enabled in any operating mode</p>	<p>The STOP/RES key on the operating panel is used for stop/reset. This parameter is used to set the function of the key.</p> <p>0: STOP/RES key enabled only in operating panel control mode The function of the key is available only in operating panel control mode.</p> <p>1: STOP/RES key enabled in any operating mode The function of the key is available in any operating mode.</p>



Para. No.	Name	Default	Value Range	Description
F7-03	LED display of parameters during operation 1	0x001F	Bit00: Running frequency (Hz) Bit01: Frequency reference (Hz) Bit02: Bus voltage (V) Bit03: Output voltage (V) Bit04: Output current (A) Bit05: Output power (kW) Bit06: Output torque (%) Bit07: DI state Bit08: DO state Bit09: AI1 voltage (V) Bit10: AI2 voltage (V) Bit11: AI3 voltage (V) Bit12: Count value Bit13: Length value Bit14: Load speed display Bit15: PID reference	In the running state, pressing the  key on the LED operating panel displays the 16 state values of the AC drive in real time. The options of each bit are 1 (display) and 0 (hide). The hexadecimal number converted from the binary number is the value of F7-03.
F7-04	LED display of parameters during operation 2	0x0000	Bit00: PID feedback Bit01: PLC stage Bit02: Pulse input reference (kHz) Bit03: Running frequency 2 (Hz) Bit04: Remaining running time Bit05: AI1 voltage before correction (V) Bit06: AI2 voltage before correction (V) Bit07: AI3 voltage before correction (V) Bit08: Linear speed Bit09: Current power-on time (Hour) Bit10: Current running time (Min) Bit11: Pulse input reference (Hz) Bit12: Communication reference Bit13: Encoder feedback speed Bit14: Display of main frequency X Bit15: Display of auxiliary frequency Y	In the running state, pressing the  key on the LED operating panel displays the 16 state values of the AC drive in real time. The options of each bit are 1 (display) and 0 (hide). The hexadecimal number converted from the binary number is the value of F7-04.

Para. No.	Name	Default	Value Range	Description
F7-05	LED display of parameters at stop	0x0033	Bit00: Frequency reference (Hz) Bit01: Bus voltage (V) Bit02: DI state Bit03: DO state Bit04: AI1 voltage (V) Bit05: AI2 voltage (V) Bit06: AI3 voltage (V) Bit07: Count value Bit08: Length value Bit09: PLC stage Bit10: Load speed Bit11: PID reference Bit12: Pulse input reference (kHz)	<p>To display these parameters at stop, set the corresponding bits to 1 and set F7-05 to a hexadecimal number obtained by converting this binary number.</p> <p>In the stop state, pressing the  key on the LED operating panel displays the 13 state values of the AC drive. The options of each bit are 1 (display) and 0 (hide). The hexadecimal number converted from the binary number is the value of F7-05.</p>
FP-01	Parameter initialization	1	0: No action 1: Restore default settings (mode 1) 2: Clear records 4: Back up current user parameters 501: Restore user backup parameters 503: Restore default settings (mode 2)	<p>This parameter is used to set the action of the AC drive upon parameter initialization.</p> <p>0: No action The AC drive takes no action.</p> <p>1: Restore default settings (mode 1) Parameters of the AC drive are restored to default settings except motor parameters, frequency reference resolution (F0-22), fault records, accumulative running time (F7-09), accumulative power-on time (F7-13), accumulative power consumption (F7-14), and heatsink temperature of IGBT (F7-07).</p> <p>2: Clear records The fault records, accumulative running time (F7-09), accumulative power-on time (F7-13), and accumulative power consumption (F7-14) are cleared.</p> <p>4: Back up current user parameters All parameter settings specific to the current user are backed up.</p> <p>501: Restore user backup parameters The parameter settings that are backed up by setting FP-01 to 4 are restored.</p> <p>503: Restore default settings (mode 2) All AC drive parameters are restored to factory settings except FP-00, FP-01, and the parameters in group FF.</p>

Para. No.	Name	Default	Value Range	Description
FP-02	Parameter group display	111	Ones: Group U display 0: Hide 1: Display Tens: Group A display 0: Hide 1: Display Hundreds: Group B display 0: Hide 1: Display Thousands: Group C display 0: Hide 1: Display	This parameter is used to determine whether the parameters in groups U, A, B, and C are displayed on the operating panel.
FP-03	User parameter group display	11	Ones: User-defined parameter group display 0: Hide 1: Display Tens: User-modified parameter group display 0: Hide 1: Display	This parameter is used to determine whether the user-defined parameters and the user-modified parameters are displayed on the operating panel through the ones and tens positions.

1.1.3 Setting Parameters

The operating panel has a three-level menu structure for parameter setting. After

entering a menu at a level, press , , and  for setting a display bit that is flashing. The following describes the structure:

- Level I menu: parameter group
- Level II menu: parameter
- Level III menu: parameter value

The following example shows how to modify F3-02 from 10.00 Hz to 15.00 Hz.

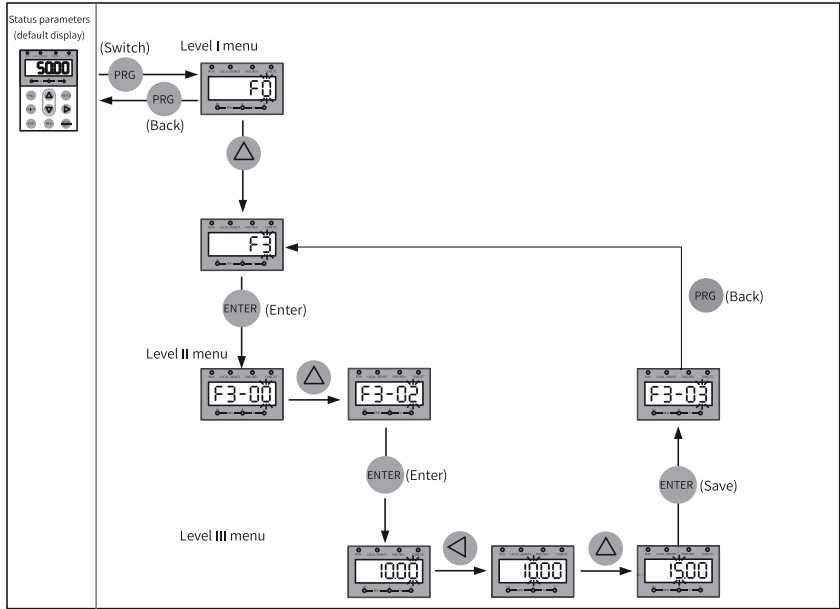

Figure 1-3 Modifying a parameter

Press **PRG** or **ENTER** to return to a level II menu when operating a level III menu. These two keys are different in that:

1. Pressing **ENTER** returns to the level II menu after saving the current parameter setting, where the next parameter is automatically displayed.
2. Pressing **PRG** returns to the level II menu corresponding to the current parameter without saving the current parameter setting.

When you are operating a level III menu, you cannot modify a parameter that does not include any flashing bit. This is because of two possible reasons:

1. The parameter is an unmodifiable parameter such as product type, actual detection, and running record parameters.
2. The parameter cannot be modified when the AC drive is running. You can modify such parameters when the AC drive is stopped.

1.1.4 Viewing Parameters

Set FP-02 to 11 and FP-03 to 11 to view all parameters through the operating panel. The following figure shows how this is done.

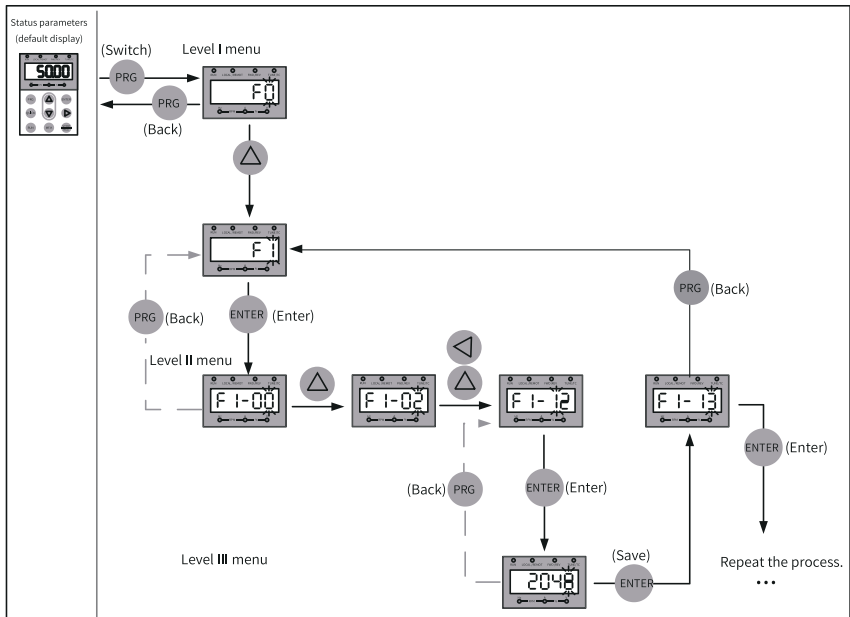



Figure 1-4 Viewing parameters

1.1.5 Viewing Status Parameters

In the running state, press  to view status parameters. The status parameters displayed by default include running frequency, frequency reference, bus voltage, output voltage, and output current. For more status parameters, see related description of F7-03 and F7-04 in "Related Parameters".

In the stop state, press  to view status parameters. The status parameters displayed by default include frequency reference, bus voltage, AI1 voltage, and AI2 voltage. For more status parameters, see related description of F7-05 in "Related Parameters".

1.1.6 Viewing Faults

When the AC drive is faulty, the fault indicator blinks, and the operating panel displays a fault code, as shown in the following figure.

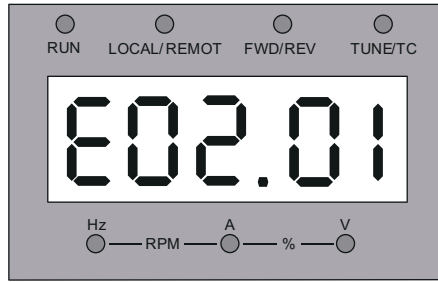

Figure 1-5 Fault code

The AC drive will immediately stop output, and the contact of the fault relay will be closed. Perform troubleshooting according to the common solutions specified in "Fault codes" or contact Inovance for technical support. Locate and rectify the fault cause based on the fault code displayed on the operating panel. Then reset to clear the fault.

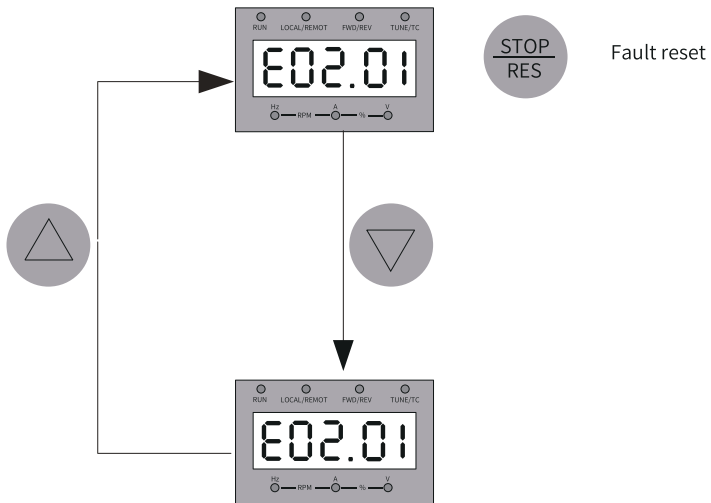

Figure 1-6 Viewing and resetting upon multiple faults

1.1.7 Operating the MF.K Key



MF.K

The **MF.K** key is a multi-function key on the operating panel. Its function can be set using F7-01. In the stop or running state, press the key for control mode switchover, switchover between forward and reverse run, and forward/reverse jog.

Table 1–6 MF.K key parameters

Para. No.	Name	Default	Value Range	Description
F7-01	MF.K key function selection	0	0: MF.K key disabled 1: Switchover between operating panel control and remote control (terminal I/O control or communication control) 2: Switchover between forward and reverse run 3: Forward jog 4: Reverse jog	This parameter is used for setting the function of the MF.K key on the operating panel. 0: MF.K key disabled The key has no function. 1: Switchover between operating panel control and remote control (terminal I/O control or communication control) When F0-02 is set to 0 (operating panel control), pressing the MF-K key produces no effect. When F0-02 is set to 1 (terminal), pressing the MF.K key can switch between terminal I/O control and operating panel control. When F0-02 is set to 2 (communication), pressing the MF.K key can switch between communication control and operating panel control. 2: Switchover between forward and reverse run Pressing the MF.K key can switch between frequency reference directions. This function is available only when the operating panel is selected as the command source. 3: Forward jog Pressing the MF.K key enables forward jog (FJOG). This function is available only when the operating panel is selected as the command source. 4: Reverse jog Pressing the MF.K key enables reverse jog (RJOG). This function is available only when the operating panel is selected as the command source.

1.1.8 Driving the Motor Using the Operating Panel

Press  on the operating panel to control forward/reverse jog of the motor and press  /  to start/stop the motor.

Procedure

1. Perform inspection before power-on.
Inspect installation and wiring as instructed in the *MD500-PLUS Series General-Purpose AC Drive Installation Guide*. For details, see the parts related to inspection before power-on in that guide.
2. Press the power switch to power on the AC drive.
3. Check the display on the operating panel. If the operating panel displays 50.00, the power-on is successful.



4. Set FP-01 to 001 to restore all parameters to default settings. The following figure shows an example.

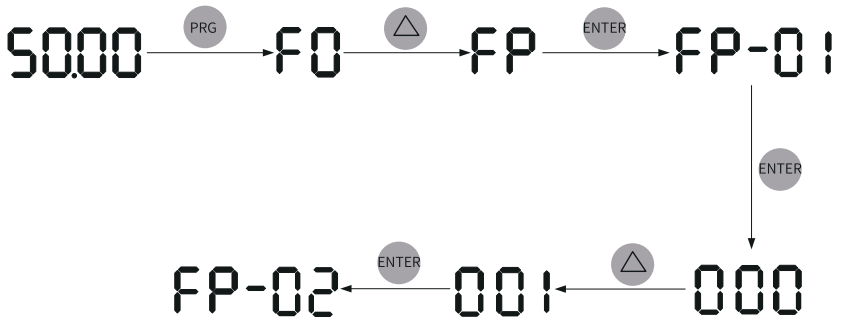

5. Check the value of F7-10, which indicates the software version.

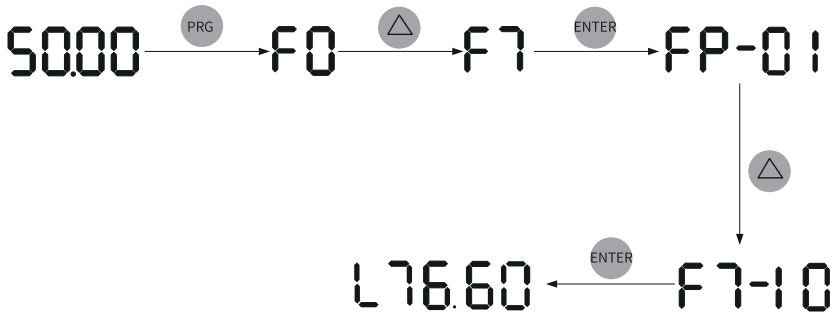

6. Set motor parameters in group F1 according to the motor nameplate.

Table 1-7 Motor parameters

Para. No.	Name	Default	Value Range	Description	Set point
F1-00	Motor type selection	0	0: Common asynchronous motor 1: Variable frequency asynchronous motor 2: Synchronous motor	A variable frequency motor adjusts its frequency and speed according to the load. It is suitable for applications with low voltage or light load. For low-voltage applications, its frequency can be reduced for reliable startup. For light-load applications, its frequency, speed, and current can be reduced to save electrical energy. Common asynchronous motors are suitable for applications with normal voltage but often full load. Designed on constant frequency and constant voltage, they are impossible to meet all frequency control requirements.	0
F1-01	Rated motor power	Model dependent	0.1–1000.0 kW	This is the shaft end output power of the motor during operation under rated working conditions. The selected value should allow cost-efficiency while being sufficient to support the required mechanical load. Factors such as motor heating, allowable overload capacity, and starting capacity should be considered.	22.0
F1-02	Rated motor voltage	Model dependent	1–2000 V	This is the voltage of the motor during normal operation, which typically refers to the line voltage.	0380

Para. No.	Name	Default	Value Range	Description	Set point
F1-03	Rated motor current	Model dependent	0.1–6553.5 A	This is the current of the motor during normal operation, which typically refers to the line current.	45.0
F1-04	Rated motor frequency	Model dependent	0.01–600.00 Hz	This is the frequency of the power supply connected to the stator winding when the motor is running in rated conditions.	50.00
F1-05	Rated motor speed	Model dependent	1–65535 RPM	This is the speed of the rotor in RPM when the motor is running in rated conditions.	1460

7. Set F1-37 to 2 and press ENTER. The keypad displays . Press and hold the RUN key for more than 3s to start motor auto-tuning. In this case, the RUN indicator is steady on, the TUNE/TC indicator blinks, and the motor is energized. About 1 minute later, the operating panel displays 50.00, indicating that the auto-tuning is done.

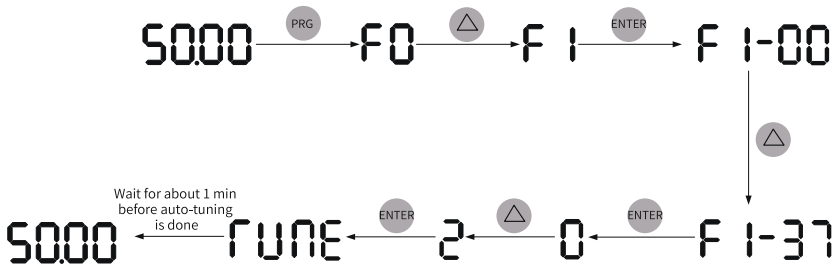

8. Set F7-01 to 3. Press  to start forward jogging.

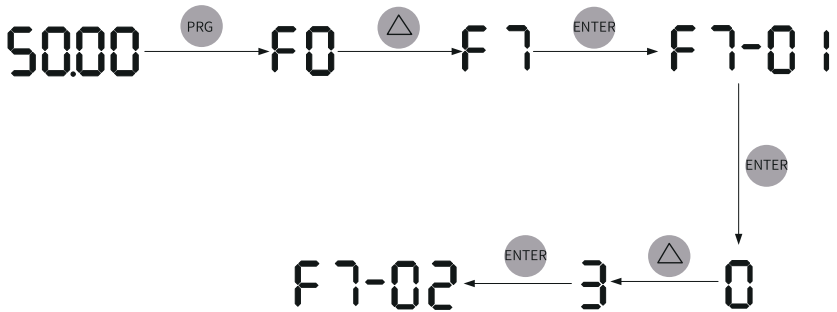

9. Set F7-01 to 4. Press (MF.K) for reverse jog of the motor.

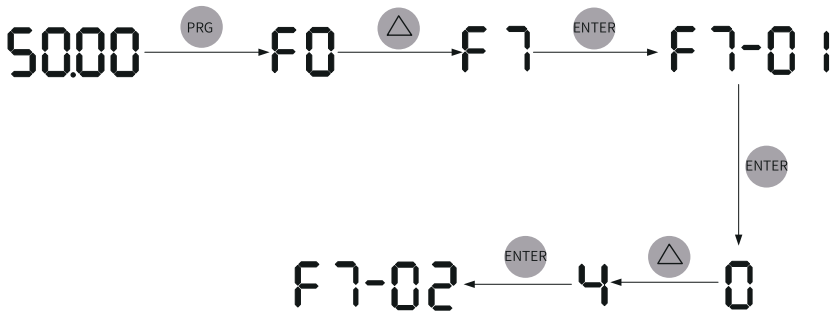

10. Press (RUN) to start the motor. The motor starts accelerating and the operating panel displays the current running frequency, as shown in the following figure. After the acceleration is done, the displayed frequency is 50.00. Press this key to switch the displayed status parameter.

50.00 5.10 ... 9.60 50.00

During acceleration, the running frequency increases dynamically.

(RUN)

11. Press (STOP/RES) to make the motor decelerate to stop.

2 Commissioning and Trial Run

2.1 Commissioning Process

2.1.1 Basic Commissioning Process

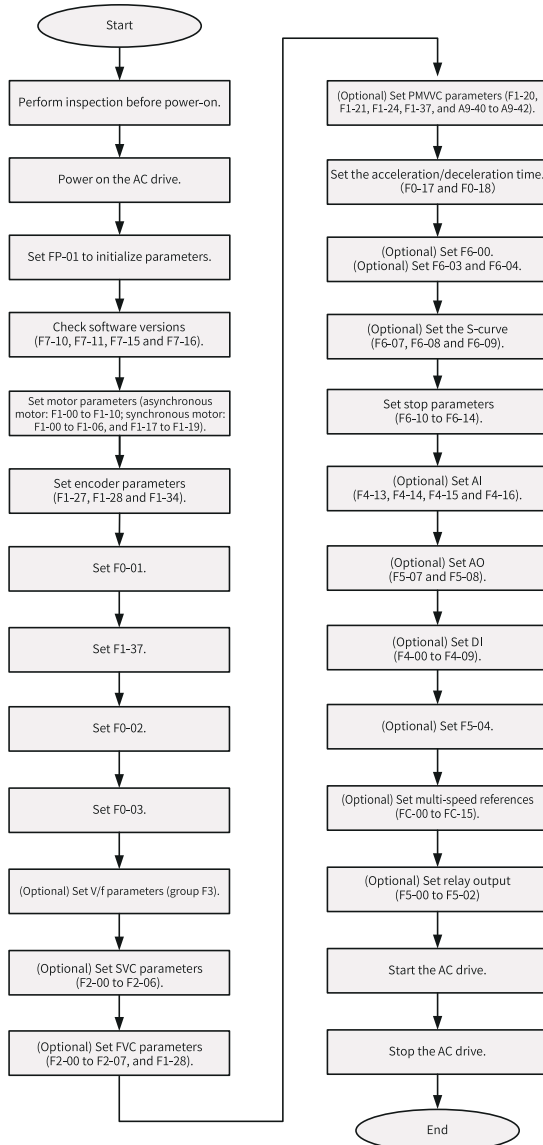

Figure 2-1 Basic commissioning flowchart

Table 2-1 Basic commissioning process

No.	Step	Related Parameters
1	Perform inspection before power-on.	None
2	Power on the AC drive.	None
3	Initialize parameters.	FP-01
4	Check software versions.	F7-10, F7-11, F7-15, and F7-16
5	Set motor parameters.	F1-00 to F1-05, and the following (motor dependent): F1-06 to F1-10 (asynchronous motor) F1-06 and F1-17 to F1-19 (synchronous motor)
6	Set encoder parameters.	F1-27, F1-28, and F1-34
7	Set the control mode.	F0-01
8	Perform auto-tuning on motor parameters.	F1-37
10	Select a command source.	F0-02
11	Select a frequency source.	F0-03
12	(Optional) Set V/f parameters.	Parameters in group F3
13	(Optional) Set SVC parameters.	F2-00 to F2-06
14	(Optional) Set FVC parameters.	F2-00 to F2-07, and F1-28
15	(Optional) Set PMVC parameters.	F0-01, F1-00, F1-20, F1-21, F1-24, F1-37, and A9-40 to A9-42
16	Set the acceleration/deceleration time.	F0-17 and F0-18
17	(Optional) Set the startup mode.	F6-00
18	(Optional) Set the startup frequency.	F6-03 and F6-04
19	(Optional) Set the S-curve.	F6-07, F6-08, and F6-09
20	Set stop parameters.	F6-10 to F6-14
21	(Optional) Set AI.	F4-13, F4-14, F4-15, and F4-16
22	(Optional) Set AO.	F5-07 and F5-08
23	(Optional) Set DI.	F4-00 to F4-09
24	(Optional) Set DO.	F5-04
25	(Optional) Set multi-speed references.	FC-00 to FC-15
26	(Optional) Set replay output.	F5-00, F5-01, and F5-02
27	Start the AC drive.	None
28	Stop the AC drive.	None

2.1.2 Commissioning Process in V/f Control Mode

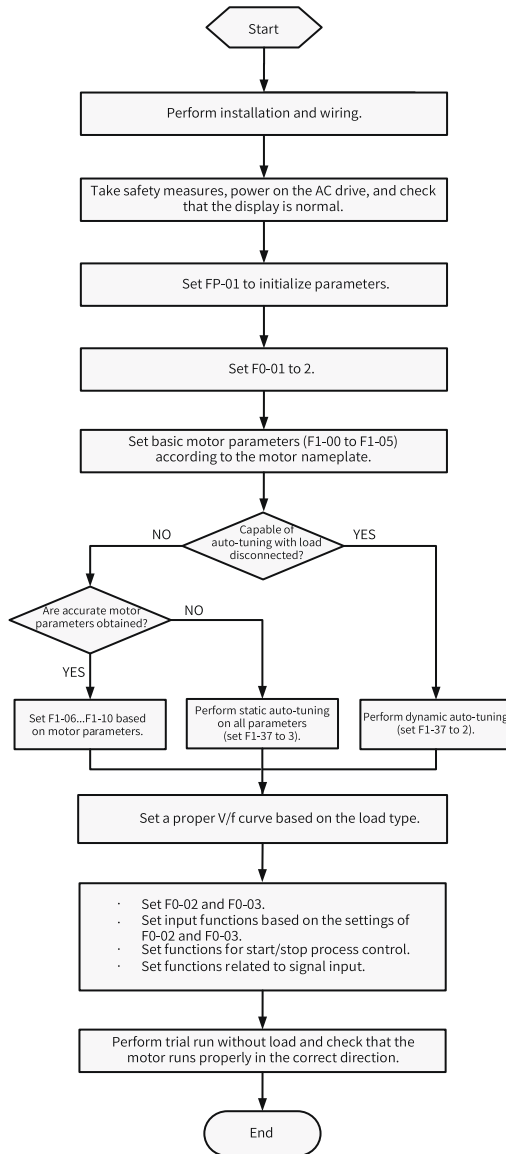

Figure 2-2 AC drive commissioning flowchart (in V/f control mode)

2.1.3 Commissioning Process in SVC/FVC Mode

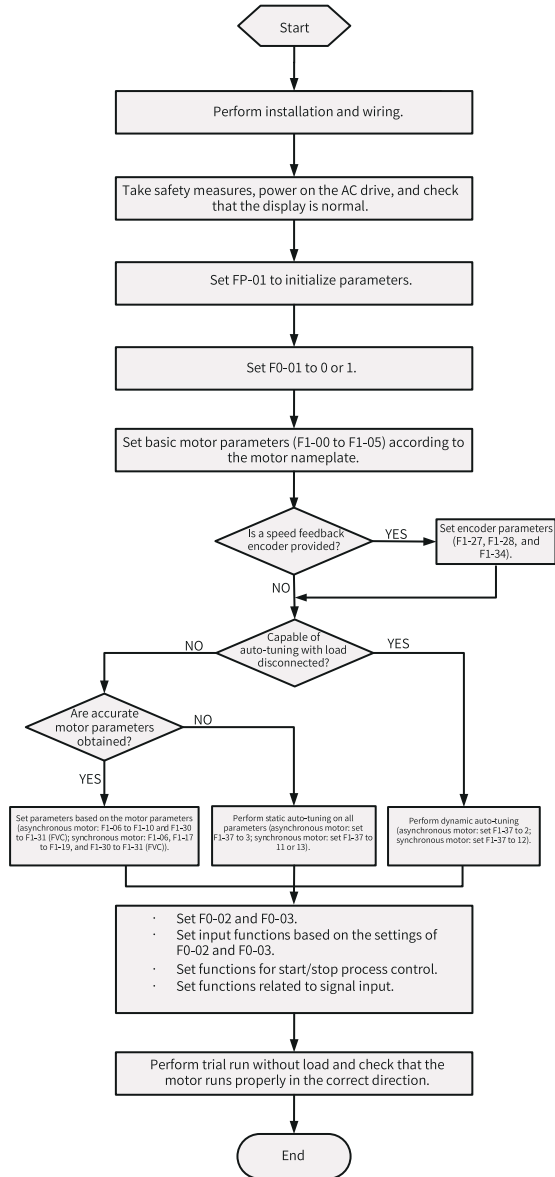

Figure 2-3 AC drive commissioning flowchart (in SVC/FVC mode)

2.1.4 Commissioning Process in PMVC Mode

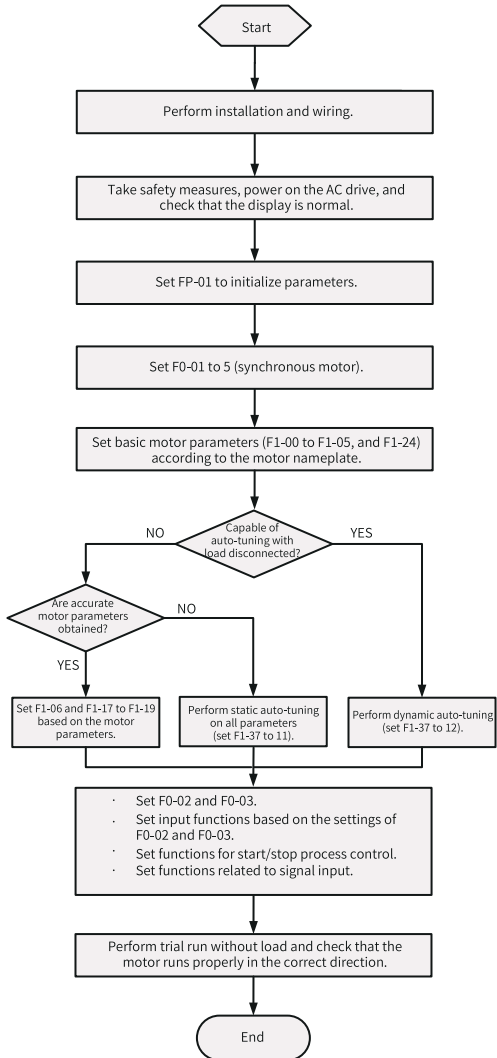

Figure 2-4 AC drive commissioning flowchart (in PMVC mode)

2.2 Commissioning Procedure

2.2.1 Checklist Before Power-on

Ensure compliance of the items in the following table before power-on.

Table 2-2 Checklist before power-on

Item	Checklist
Main circuit wiring	The power supply voltage is correct (380–480 VAC; 50/60 Hz).
	The power input terminals and the AC drive input terminals (R/S/T) are connected properly.
	The motor input terminals and the AC drive output terminals (U/V/W) are connected properly.
	The AC drive and motor are properly grounded.
	The cross sectional area of the main circuit cable is proper.
	The heat-shrink tube is applied to the copper lug and conductors of the main circuit cable and the tube completely wraps the conducting parts of the cable.
	The motor output cable is shorter than 50 m, or the carrier frequency (F0-15) is reduced otherwise.
Control circuit wiring	The control circuit terminals are reliably connected to other control devices.
	The control circuit signal cables in use are shielded twisted pair cables.
	Optional cards are connected correctly.
	Control circuit cables and main circuit cables are routed through different routes.
	The control circuit terminals of the AC drive are all OFF (the AC drive is not running).
Load	The motor is not connected to any load or mechanical system.
Braking resistor	The braking resistor and braking unit, where applicable, are wired properly with proper resistance value.

2.2.2 Powering on the AC Drive

Switch off the power switch and check the display on the operating panel of the AC drive. If the operating panel displays 50.00, the AC drive is powered on properly.



Figure 2-5 Power-on display on the operating panel

2.2.3 Initializing Parameters

Para. No.	Name	Default	Value Range	Description
FP-01	Parameter initialization	0	0: No action 1: Restore default settings (mode 1) 2: Clear records 4: Back up current user parameters 501: Restore user backup parameters 503: Restore default settings (mode 2)	This parameter is used to set the action of the AC drive upon parameter initialization. 0: No action The AC drive takes no action. 1: Restore default settings (mode 1) Parameters of the AC drive are restored to default settings except motor parameters, frequency reference resolution (F0-22), fault records, accumulative running time (F7-09), accumulative power-on time (F7-13), accumulative power consumption (F7-14), and heatsink temperature of IGBT (F7-07). 2: Clear records The fault records, accumulative running time (F7-09), accumulative power-on time (F7-13), and accumulative power consumption (F7-14) are cleared. 4: Back up current user parameters All parameter settings specific to the current user are backed up. 501: Restore user backup parameters The parameter settings that are backed up by setting FP-01 to 4 are restored. 503: Restore default settings (mode 2) All AC drive parameters are restored to factory settings except FP-00, FP-01, and the parameters in group FF.

2.2.4 Checking Software Versions

Para. No.	Name	Value Range	Description
F7-10	Performance software version	-	Indicates the performance software version of the AC drive.
F7-11	Function software version	-	Indicates the function software version of the AC drive.
F7-15	Temporary performance software version	-	Indicates the temporary performance software version.
F7-16	Temporary function software version	-	Indicates the temporary function software version.

2.2.5 Setting Motor Parameters

Para. No.	Name	Value Range	Description
F1-00	Motor type selection	0: Common asynchronous motor 1: Variable frequency asynchronous motor 2: Synchronous motor	A variable frequency motor adjusts its frequency and speed according to the load. It is suitable for applications with low voltage or light load. For low-voltage applications, its frequency can be reduced for reliable startup. For light-load applications, its frequency, speed, and current can be reduced to save electrical energy. Common asynchronous motors are suitable for applications with normal voltage but often full load. Designed on constant frequency and constant voltage, they are impossible to meet all frequency control requirements.
F1-01	Rated motor power	0.1–1000.0 kW	This is the shaft end output power of the motor during operation under rated working conditions. The selected value should allow cost-efficiency while being sufficient to support the required mechanical load. Factors such as motor heating, allowable overload capacity, and starting capacity should be considered.
F1-02	Rated motor voltage	1–2000 V	This is the voltage of the motor during normal operation, which typically refers to the line voltage.
F1-03	Rated motor current	0.1–6553.5 A	This is the current of the motor during normal operation, which typically refers to the line current.
F1-04	Rated motor frequency	0.01–600.00 Hz	This is the frequency of the power supply connected to the stator winding when the motor is running in rated conditions.
F1-05	Rated motor speed	1–65535 RPM	This is the speed of the rotor in RPM when the motor is running in rated conditions.
F1-06	Asynchronous/Synchronous motor stator resistance	0.001–65.535 Ω (power: ≤ 55 kW) 0.0001–6.5535 Ω (power: > 55 kW)	This is the DC resistance of the motor stator winding, which can be obtained through motor auto-tuning.

Para. No.	Name	Value Range	Description
F1-07	Asynchronous motor rotor resistance	0.001 (power: \leq 55 kW) 0.0001 (power: > 55 kW)	This is the DC resistance of rotor winding of an asynchronous motor, which can be obtained by static or dynamic motor auto-tuning.
F1-08	Asynchronous motor leakage inductance	0.01–655.35 mH (power: \leq 55 kW) 0.001–65.535 mH (power: > 55 kW)	The asynchronous motor leakage inductance is caused by the leakage flux of the motor winding. The winding of the motor produces magnetic flux when current is introduced. By path, the magnetic flux can be divided into two parts: main flux and leakage flux. The leakage flux can be described by an inductance, namely, leakage inductance. It can be obtained through static or dynamic motor auto-tuning.
F1-09	Asynchronous motor mutual inductance	0.1–6553.5 mH (power: \leq 55 kW) 0.01–655.35 mH (power: > 55 kW)	When the current in one coil of the motor changes, electromotive force is induced in a coil adjacent to it. Such mutually induced electromotive force can be described by this parameter. The mutual inductance of a motor can be roughly divided into two types. One is the interphase inductance of the stator or rotor, which is the reactance between two phases of the stator or rotor. The other is the inductance between the stator and the rotor. The former does not change with the rotation of the rotor, while the latter changes accordingly with the rotation of the rotor. Both types of mutual inductance can be obtained through static or dynamic motor auto-tuning.
F1-10	Asynchronous motor no-load current	0.1–6553.5 A	This is the current passing through the three-phase windings of the stator when the motor is running with no load. It can be obtained through dynamic motor auto-tuning.
F1-17	Synchronous motor axis D inductance	0.01–655.35 mH (power: \leq 55 kW) 0.001–65.535 mH (power: > 55 kW)	This is the inductance of the main magnetic pole axis (vertical axis) of a synchronous motor.
F1-18	Synchronous motor axis Q inductance	0.01–655.35 mH (power: \leq 55 kW) 0.001–65.535 mH (power: > 55 kW)	This is the inductance experienced at the central line (quadrature axis) between adjacent magnetic pole axes of the rotor of a synchronous motor.
F1-19	Synchronous motor back EMF coefficient	0.0–6553.5 V	This is the RMS value of the back EMF line of the motor at the rated frequency specified by F1-04.
F1-20	Filter time constant (PMVVC)	0.003–65.535	This is a parameter applicable to the PMVVC mode.
F1-21	Oscillation suppression gain (PMVVC)	0–65535	This is a parameter applicable to the PMVVC mode.
F1-23	Percentage of the frictional moment	0.00% to 100.00%	-
F1-24	Number of motor pole pairs	0–65535	-

Para. No.	Name	Value Range	Description
F1-26	Auto-tuning direction (inertia auto-tuning and synchronous motor auto-tuning)	0–1	-
F1-27	Encoder pulses per revolution	1–20000	This is the number of pulses generated per revolution of the encoder disk. In feedback vector control (FVC) mode, an improper number of such pulses may cause malfunction of the motor.
F1-28	Encoder type	0: ABZ incremental encoder 1: 23-bit encoder 2: Resolver	Encoders are classified into incremental encoders and absolute encoders. An incremental encoder converts displacement into periodic electrical signals, and then converts the electrical signals into pulses that are counted. The number of pulses describes the magnitude of the displacement. Each position of an absolute encoder corresponds to a certain digital code. Therefore, its indication is related only to the start and end positions of the measurement.
F1-29	PG signal filter	0: Non-adaptive filter 1: Adaptive filter 2: Fixed interlock 3: Automatic interlock	-
F1-30	Encoder wiring flag	Ones (position): AB signal direction or rotational direction Tens (position): Reserved	-
F1-31	Encoder zero position angle	0.0° to 359.9°	-
F1-32	Motor gear ratio numerator	1–65535	-
F1-33	Motor gear ratio denominator	1–65535	-

2.2.6 Performing Auto-tuning on Motor Parameters

Enter motor parameters (F1-00 to F1-05) correctly according to the motor nameplate. Set F1-37 to 1 (asynchronous motor static auto-tuning) and press ENTER. The operating panel displays TUNE. Press the RUN key to start motor auto-tuning. When

the operating panel displays 50.00, auto-tuning is done, after which the values of F1-06 to F1-10 are obtained and written automatically by the AC drive.

Para. No.	Name	Default	Value Range	Description
F1-37	Auto-tuning selection	0	<p>0: No auto-tuning</p> <p>1: Asynchronous motor static auto-tuning</p> <p>2: Dynamic auto-tuning on all parameters of asynchronous motor</p> <p>3: With-load auto-tuning on all parameters of asynchronous motor</p> <p>4: Asynchronous motor inertia auto-tuning (only in FVC mode)</p> <p>11: No-load auto-tuning on partial parameters of synchronous motor (excluding back EMF)</p> <p>12: Synchronous motor dynamic no-load auto-tuning</p> <p>13: Static auto-tuning on all parameters of synchronous motor</p>	<p>0: No action</p> <p>Motor auto-tuning is disabled.</p> <p>1: Static auto-tuning on partial parameters of asynchronous motor</p> <p>This method is applicable to scenarios where the motor cannot be disconnected from load and dynamic auto-tuning is not allowed.</p> <p>Auto-tuning is performed on partial motor parameters including F1-06 (asynchronous motor stator resistance), F1-07 (asynchronous motor rotor resistance), and F1-08 (asynchronous motor leakage inductance).</p> <p>2: Dynamic auto-tuning on all parameters of asynchronous motor</p> <p>This method is applicable to scenarios where the motor can be easily disconnected from the application system.</p> <p>Auto-tuning is performed on all the motor parameters: F1-06 (asynchronous motor stator resistance), F1-07 (asynchronous motor rotor resistance), F1-08 (asynchronous motor leakage inductance), F1-09 (asynchronous motor mutual inductance), and F1-10 (asynchronous motor no-load current).</p> <p>3: With-load auto-tuning on all parameters of asynchronous motor</p> <p>This mode is also called static auto-tuning on all parameters of asynchronous motor. It is applicable to applications where it is difficult to disconnect the motor from the load, and dynamic auto-tuning on all parameters is not allowed.</p> <p>Auto-tuning is performed on all the motor parameters: F1-06 (asynchronous motor stator resistance), F1-07 (asynchronous motor rotor resistance), F1-08 (asynchronous motor leakage inductance), F1-09 (asynchronous motor mutual inductance), F1-10 (asynchronous motor no-load current), and F1-30 (encoder phase sequence).</p> <p>4: Asynchronous motor inertia auto-tuning (only in FVC mode)</p> <p>11: Static auto-tuning on partial parameters of synchronous motor (excluding back EMF)</p> <p>12: No-load dynamic auto-tuning on all parameters of synchronous motor</p> <p>13: Static auto-tuning on all parameters of synchronous motor (excluding the encoder installation angle)</p>

2.2.7 Selecting a Command Source

Set F0-02 to select a command source, which is the source or input mode of commands to control the startup, stop, forward run, reverse run, and jog of the AC drive.

Para. No.	Name	Default	Value Range	Description
F0-02	Command source selection	0	0: Operating panel 1: Terminal 2: Communication	<p>This parameter specifies the input mode of AC drive control commands, including start/stop, forward run, reverse run, and jog.</p> <p>0: Operating panel Control commands are input using the RUN, STOP/RES, and MF.K keys on the operating panel. This mode is suitable for initial commissioning.</p> <p>1: Terminal Control commands are input through DI terminals of the AC drive. These commands are set as appropriate to the application, such as start/stop, forward/reverse run, jog, two-wire/three-wire mode, and multi-speed operation. This mode is suitable for most applications.</p> <p>2: Communication Control commands are input through remote communication. The AC drive must be equipped with a communication card to realize communication with the host controller. This mode is suitable for remote control and centralized control on multiple devices or systems.</p>

2.2.8 Selecting a Frequency Source

Para. No.	Name	Default	Value Range	Description
F0-03	Main frequency source X selection	0	<p>0: Digital setting (preset frequency (F0-08) that can be changed by pressing UP/DOWN; non-retentive upon power failure)</p> <p>1: Digital setting (preset frequency (F0-08) that can be changed by pressing UP/DOWN; retentive at power failure)</p> <p>2: AI1</p> <p>3: AI2</p> <p>4: AI3</p> <p>5: Pulse reference (DI5)</p> <p>6: Multi-reference</p> <p>7: Simple PLC</p> <p>8: PID</p> <p>9: Communication</p>	<p>0: Digital setting (non-retentive upon power failure) The initial value of the frequency reference is the value of F0-08 (preset frequency). The value can be changed by pressing ▲/▼ on the operating panel (or pressing UP/DOWN of the multi-function terminals). When the AC drive is powered on again after power failure, the value is restored to the value of F0-08.</p> <p>1: Digital setting (retentive at power failure) The initial value of the frequency reference is the value of F0-08 (preset frequency). The value can be changed by pressing ▲/▼ on the operating panel (or pressing UP/DOWN of the multi-function terminals). After a power cycle, the frequency reference is that before the last power failure. The value set by pressing ▲/▼ or pressing UP/DOWN is retained.</p> <p>2: AI1 The frequency reference is input by AI1. The frequency is calculated by the current or voltage signal input by AI1 according to the set AI curve.</p> <p>3: AI2 The frequency reference is input by AI2. The frequency is calculated by the current or voltage signal input by AI2 according to the set AI curve.</p> <p>4: AI3 The frequency reference is input by AI3. The frequency is calculated by the current or voltage signal input by AI3 according to the set AI curve.</p> <p>5: Pulse reference (DI5) The frequency reference is set by DI5. The frequency is calculated by the mapping curve of the pulse frequency and frequency reference.</p>

Para. No.	Name	Default	Value Range	Description
	(Continued)			<p>6: Multi-reference When a multi-reference is configured for the frequency reference, you can set different frequency reference values by flexibly combining DI terminal states. The four multi-reference terminals can have 16 state combinations, representing 16 frequency reference values.</p> <p>7: Simple PLC The value is a multi-reference used to control the running time and acceleration/deceleration time. FC-00 to FC-15 are used to set the values of each frequency. FC-18 to FC-49 are used to set the running time and acceleration/deceleration time of each frequency. A maximum of 16 references can be set.</p> <p>8: PID PID is selected as the main frequency source. PID control is a common process control method, which calculates the proportion, integral, and differential of the difference between feedback signals and target signals of the controlled variable, and adjusts the output frequency of the AC drive accordingly. This method finally creates a closed-loop system to stabilize the controlled variable at the target value. Generally, PID output can be used as the frequency reference for on-site closed-loop process control applications, such as closed-loop pressure control and closed-loop tension control.</p> <p>9: Communication The main frequency value is set through communication. The frequency reference is input through remote communication. The AC drive must be equipped with a communication card to realize communication with the host controller. This mode is suitable for remote control and centralized control on multiple devices or systems.</p>

2.2.9 Setting the Control Mode

Para. No.	Name	Default	Value Range	Description
F0-01	Motor 1 control mode	0	0: Sensorless vector control (SVC) 1: Feedback vector control (FVC) 2: V/f control 5: PMVVC (applicable only to synchronous motors)	0: Sensorless vector control (SVC) This is open-loop vector control applied to high-performance control applications. One AC drive can drive only one motor. It is used for loads such as machine tools, centrifuges, wire drawing machines, and injection molding machines. 1: Feedback vector control (FVC) This is closed-loop vector control. An encoder must be installed at the motor end, and the AC drive must be equipped with a PG card of the same type as the encoder. It is applicable to applications requiring high-precision speed control and torque control. One AC drive can drive only one motor. It is used for loads such as high-speed paper machines, cranes, and elevators. 2: V/f control This mode is applicable to applications that do not require high load control performance, such as fans and pumps. If one AC drive is required to drive multiple motors, only the V/f control mode can be used. 5: PMVVC (open-loop speed control of synchronous motor) This mode is used for loads such as fans and water pumps that do not require high accuracy.

2.2.10 Setting V/f Parameters (Optional)

Para. No.	Name	Default	Value Range	Description
F3-00	V/F curve setting	0	<p>0: Linear V/f curve</p> <p>1: Multi-point V/f curve</p> <p>2: Square V/f curve</p> <p>3: 1.2-power V/f curve</p> <p>4: 1.4-power V/f curve</p> <p>6: 1.6-power V/f curve</p> <p>8: 1.8-power V/f curve</p> <p>10: Complete V/f separation</p> <p>11: Incomplete V/f separation</p>	<p>0: Linear V/f curve Below the rated frequency, the output voltage and output frequency of the AC drive change linearly. This curve is applicable to common mechanical drive applications such as large inertia fan acceleration, punch presses, centrifuges, and water pumps.</p> <p>1: Multi-point V/f curve Frequency points are in the range of 0.00 Hz to the rated motor frequency, and voltage points are in the range of 0.0% to 100.0%, corresponding to the voltage range of 0 V to the rated motor voltage. Generally, the voltage and frequency values are set based on load characteristics of the motor. The parameter settings must meet the following condition: Value of F3-03 ≤ Value of F3-05 ≤ Value of F3-07.</p> <p>2: Square V/f curve Below the rated motor frequency, the output voltage of the AC drive changes quadratically with the output frequency. This curve is applicable to light loads that seldom change, such as fans and water pumps.</p> <p>3: 1.2-power V/f curve Below the rated motor frequency, the output voltage of the AC drive changes with the output frequency by 1.2 power.</p> <p>4: 1.4-power V/f curve Below the rated motor frequency, the output voltage of the AC drive changes with the output frequency by 1.4 power.</p> <p>6: 1.6-power V/f curve Below the rated motor frequency, the output voltage of the AC drive changes with the output frequency by 1.6 power.</p> <p>8: 1.8-power V/f curve Below the rated motor frequency, the output voltage of the AC drive changes with the output frequency by 1.8 power.</p> <p>10: Complete V/f separation The output frequency and output voltage of the AC drive are independent of each other. The output frequency is determined by the frequency source, and the output voltage is determined by the voltage source for V/f separation. This mode is typically applicable to applications such as motor torque control.</p> <p>11: Incomplete V/f separation In this mode, the voltage is proportional to the frequency. The proportional relationship can be set through the voltage source, and the relationship between voltage and frequency is also related to the rated motor voltage and rated motor frequency in group 1. Assume that the power source input is X (0% to 100%). The output voltage of the AC drive and the frequency can be calculated using the following formula: $V/f = 2 \times X \times (\text{Rated motor voltage}) / (\text{Rated motor frequency})$</p>

2.2.11 Setting SVC Parameters (Optional)

Para. No.	Name	Default	Value Range	Description
F2-00	Low-speed speed loop Kp	30 (async. motor) 20 (sync. motor)	1–200	This is the PID control parameter Kp for the speed loop, which affects the response speed of the motor speed. A larger Kp value indicates higher sensitivity and more intensive tuning. A smaller Kp value indicates lower sensitivity and less intensive tuning. The low-speed speed loop Kp is effective at low speed.
F2-01	Low-speed speed loop Ti	0.500s	0.001–10.000s	The reciprocal of the speed loop integral time constant is the integral gain. The speed loop integral time constant affects the steady-state speed error of the motor and the stability of the speed loop system. If the speed loop integral time constant increases, the speed loop response slows down. For quicker response, a larger speed loop proportional gain is required. The low-speed speed loop Ti is effective at low speed.
F2-02	Switchover frequency 1	5.00 Hz	0.00 to switchover frequency 2 (F2-05)	Speed loop PI parameters are divided into low-speed and high-speed groups. When the running frequency is lower than switchover frequency 1 (F2-02), F2-00 and F2-01 are tuned. When the running frequency is higher than switchover frequency 2 (F2-05), F2-03 and F3-04 are tuned. If the running frequency is between switchover frequency 1 and switchover frequency 2, the speed loop PI parameters switch linearly between the two groups of PI parameters. This parameter must be set less than switchover frequency 2 (F2-05).
F2-03	High-speed speed loop Kp	20	1–200	This is the PID control parameter Kp for the speed loop, which affects the response speed of the motor speed. A larger Kp value indicates higher sensitivity and more intensive tuning. A smaller Kp value indicates lower sensitivity and less intensive tuning. The high-speed speed loop Kp is effective at high speed.
F2-04	High-speed speed loop Ti	1.000s	0.001–10.000s	The reciprocal of the speed loop integral time constant is the integral gain. The speed loop integral time constant affects the steady-state speed error of the motor and the stability of the speed loop system. If the speed loop integral time constant increases, the speed loop response slows down. For quicker response, a larger speed loop proportional gain is required. The high-speed speed loop Ti is effective at high speed.

Para. No.	Name	Default	Value Range	Description
F2-05	Switchover frequency 2	10.00 Hz	Value of F2-02 to the maximum frequency	Speed loop PI parameters are divided into low-speed and high-speed groups. When the running frequency is lower than switchover frequency 1 (F2-02), F2-00 and F2-01 are tuned. When the running frequency is higher than switchover frequency 2 (F2-05), F2-03 and F3-04 are tuned. If the running frequency is between switchover frequency 1 and switchover frequency 2, the speed loop PI parameters switch linearly between the two groups of PI parameters.
F2-06	VC slip compensation gain	100%	50% to 200%	In SVC mode, this parameter can be used to adjust the speed stability accuracy. For example, increase this parameter when the running frequency of the motor is lower than the output frequency of the AC drive. In FVC mode, this parameter can be used to adjust output current of the AC drive. For example, decrease this parameter gradually when a high-rate AC drive is used to control a motor with low load capacity. You do not need to change the value of this parameter in most cases.

2.2.12 Setting FVC Parameters (Optional)

Para. No.	Name	Default	Value Range	Description
F1-27	Encoder pulses per revolution	1024	1–20000	This is the number of pulses generated per revolution of the encoder disk. In feedback vector control (FVC) mode, an improper number of such pulses may cause malfunction of the motor.
F1-34	Number of pole pairs of resolver	1	1–32	A resolver is an electromagnetic transducer, also known as a synchronous resolver. It is a small AC motor used to measure angles. It consists of stators and rotors and is used to measure the shaft angular displacement and angular velocity of a revolving object. This parameter indicates the number of pole pairs of a resolver. A larger number of pole pairs indicates higher accuracy.
F2-00	Low-speed speed loop Kp	30 (asynchronous motor) 20 (synchronous motor)	1–200	This is the PID control parameter Kp for the speed loop, which affects the response speed of the motor speed. A larger Kp value indicates higher sensitivity and more intensive tuning. A smaller Kp value indicates lower sensitivity and less intensive tuning. The low-speed speed loop Kp is effective at low speed.

Para. No.	Name	Default	Value Range	Description
F2-01	Low-speed speed loop Ti	0.500s	0.001–10.000s	The reciprocal of the speed loop integral time constant is the integral gain. The speed loop integral time constant affects the steady-state speed error of the motor and the stability of the speed loop system. If the speed loop integral time constant increases, the speed loop response slows down. For quicker response, a larger speed loop proportional gain is required. The low-speed speed loop Ti is effective at low speed.
F2-02	Switchover frequency 1	5.00 Hz	0.00 to switchover frequency 2 (F2-05)	Speed loop PI parameters are divided into low-speed and high-speed groups. When the running frequency is lower than switchover frequency 1 (F2-02), F2-00 and F2-01 are tuned. When the running frequency is higher than switchover frequency 2 (F2-05), F2-03 and F3-04 are tuned. If the running frequency is between switchover frequency 1 and switchover frequency 2, the speed loop PI parameters switch linearly between the two groups of PI parameters. This parameter must be set less than switchover frequency 2 (F2-05).
F2-03	High-speed speed loop Kp	20	1–200	This is the PID control parameter Kp for the speed loop, which affects the response speed of the motor speed. A larger Kp value indicates higher sensitivity and more intensive tuning. A smaller Kp value indicates lower sensitivity and less intensive tuning. The high-speed speed loop Kp is effective at high speed.
F2-04	High-speed speed loop Ti	1.000s	0.001–10.000s	The reciprocal of the speed loop integral time constant is the integral gain. The speed loop integral time constant affects the steady-state speed error of the motor and the stability of the speed loop system. If the speed loop integral time constant increases, the speed loop response slows down. For quicker response, a larger speed loop proportional gain is required. The high-speed speed loop Ti is effective at high speed.
F2-05	Switchover frequency 2	10.00 Hz	Value of F2-02 to the maximum frequency	Speed loop PI parameters are divided into low-speed and high-speed groups. When the running frequency is lower than switchover frequency 1 (F2-02), F2-00 and F2-01 are tuned. When the running frequency is higher than switchover frequency 2 (F2-05), F2-03 and F3-04 are tuned. If the running frequency is between switchover frequency 1 and switchover frequency 2, the speed loop PI parameters switch linearly between the two groups of PI parameters. This parameter must be set less than switchover frequency 2 (F2-05).

Para. No.	Name	Default	Value Range	Description
F2-06	VC slip compensation gain	100%	50% to 200%	In SVC mode, this parameter can be used to adjust the speed stability accuracy. For example, increase this parameter when the running frequency of the motor is lower than the output frequency of the AC drive. In FVC mode, this parameter can be used to adjust output current of the AC drive. For example, decrease this parameter gradually when a high-rate AC drive is used to control a motor with low load capacity. You do not need to change the value of this parameter in most cases.
F2-07	Speed loop feedback filter time	0.004s	0.000–0.100s	In FVC mode (F0-01 set to 1), the speed loop feedback filter time is effective. Adjusting the parameter can improve the motor stability. A larger value indicates better motor stability but slower dynamic response, and a smaller value indicates faster dynamic response. A small value of this parameter may result in motor oscillation. Generally, the motor stability meets requirements, and you do not need to modify this parameter.
F1-27	Encoder pulses per revolution	1024	1–20000	This is the number of pulses generated per revolution of the encoder disk. In feedback vector control (FVC) mode, an improper number of such pulses may cause malfunction of the motor.
F1-28	Encoder type	1	0: ABZ incremental encoder 1: 23-bit encoder 2: Resolver	Encoders are classified into incremental encoders and absolute encoders. An incremental encoder converts displacement into periodic electrical signals, and then converts the electrical signals into pulses that are counted. The number of pulses describes the magnitude of the displacement. Each position of an absolute encoder corresponds to a certain digital code. Therefore, its indication is related only to the start and end positions of the measurement.
F1-34	Number of pole pairs of resolver	1	1–32	A resolver is an electromagnetic transducer, also known as a synchronous resolver. It is a small AC motor used to measure angles. It consists of stators and rotors and is used to measure the shaft angular displacement and angular velocity of a revolving object. This parameter indicates the number of pole pairs of a resolver. A larger number of pole pairs indicates higher accuracy.

2.2.13 Setting PMVC Parameters (Optional)

Para. No.	Name	Default	Value Range	Description
F0-01	Motor 1 control mode	0	<p>0: Sensorless vector control (SVC)</p> <p>1: Feedback vector control (FVC)</p> <p>2: V/f control</p> <p>5: PMVC (applicable only to synchronous motors)</p>	<p>0: Sensorless vector control (SVC) This is open-loop vector control applied to high-performance control applications. One AC drive can drive only one motor. It is used for loads such as machine tools, centrifuges, wire drawing machines, and injection molding machines.</p> <p>1: Feedback vector control (FVC) This is closed-loop vector control. An encoder must be installed at the motor end, and the AC drive must be equipped with a PG card of the same type as the encoder. It is applicable to applications requiring high-precision speed control and torque control. One AC drive can drive only one motor. It is used for loads such as high-speed paper machines, cranes, and elevators.</p> <p>2: V/f control (speed open loop control) This mode is applicable to applications that do not require high load control performance, such as fans and pumps. If one AC drive is required to drive multiple motors, only the V/f control mode can be used.</p> <p>5: PMVC (open-loop speed control of synchronous motor) This mode is used for loads such as fans and water pumps that do not require high accuracy.</p>
F1-00	Motor type selection	0	<p>0: Common asynchronous motor</p> <p>1: Variable frequency asynchronous motor</p> <p>2: Synchronous motor</p>	<p>A variable frequency motor adjusts its frequency and speed according to the load. It is suitable for applications with low voltage or light load. For low-voltage applications, its frequency can be reduced for reliable startup. For light-load applications, its frequency, speed, and current can be reduced to save electrical energy.</p> <p>Common asynchronous motors are suitable for applications with normal voltage but often full load. Designed on constant frequency and constant voltage, they are impossible to meet all frequency control requirements.</p>
F1-20	Filter time constant (PMVC)	0.100	0.003–65.535	This is a parameter applicable to the PMVC mode.
F1-21	Oscillation suppression gain (PMVC)	100	0–65535	This is a parameter applicable to the PMVC mode.

Para. No.	Name	Default	Value Range	Description
F1-24	Number of motor pole pairs	2	0–65535	-
F1-37	Auto-tuning selection	0	0: No auto-tuning 1: Static auto-tuning on partial parameters of asynchronous motor 2: Dynamic auto-tuning on all parameters of asynchronous motor 3: With-load auto-tuning on all parameters of asynchronous motor 4: Asynchronous motor inertia auto-tuning (only in FVC mode) 11: Static auto-tuning on partial parameters of the synchronous motor (excluding back EMF) 12: No-load dynamic auto-tuning on all parameters of synchronous motor 13: Static auto-tuning on all parameters of synchronous motor (excluding the encoder installation angle) 14: Synchronous motor inertia auto-tuning (only in FVC mode)	-
A9-40	Low-speed closed-loop current selection (for VVC)	0	0–1	-
A9-41	Low-speed closed-loop current (for VVC)	50%	30% to 200%	-
A9-42	Oscillation suppression damping coefficient (for VVC)	100%	0% to 500%	-
A9-43	Initial position compensation angle (for VVC)	0	0–5	-

2.2.14 Setting the Acceleration/Deceleration Time

Para. No.	Name	Default	Value Range	Description
F0-17	Acceleration time 1	20.0s	0.0–6500.0s	<p>This is the time required for the output frequency to increase from 0 to the acceleration/deceleration time base frequency (F0-25). Generally, the acceleration time is determined by the increase of the frequency reference signal. The frequency reference rise rate must be limited to prevent overcurrent during acceleration of the motor.</p> <p>The acceleration time must be set such that the acceleration current is below the overcurrent capacity of the AC drive to avoid that the AC drive trips due to overcurrent stall.</p>
F0-18	Deceleration time 1	20.0s	0.0–6500.0s	<p>This is the time required for the output frequency to decrease from the acceleration/deceleration time base frequency (F0-25) to 0. Generally, the deceleration time is determined by the decrease of the frequency reference signal. The frequency reference drop rate must be limited to prevent overvoltage during deceleration of the motor.</p> <p>The deceleration time must be set such that the smoothing circuit voltage is not excessive to avoid that the AC drive trips due to overvoltage stall.</p>
F0-25	Acceleration/Deceleration time base frequency	0	0: Maximum frequency (F0-10) 1: Target frequency 2: 100 Hz	<p>This parameter is used for setting the target frequency for acceleration and the start frequency for deceleration.</p>

2.2.15 Setting the Startup Mode (Optional)

Para. No.	Name	Default	Value Range	Description
F6-00	Startup mode	0	0: Direct start 1: Flying start (asynchronous motor) 2: Vector pre-excitation start (asynchronous motor)	<p>0: Direct start This mode is applicable to most load conditions. Direct start upon reaching the startup frequency is applicable to lifting loads, such as elevators and cranes.</p> <p>1: Flying start This mode is applicable to scenarios where the motor is not static before the startup of AC drive, for example, large-inertia restart upon an instantaneous power failure. In some applications, the motor rotates before the AC drive is started. In this mode, the AC drive can automatically follow the motor speed and direction, allowing smooth startup of the AC drive without impact on the running motor. For example, when the AC drive is running, an instantaneous power failure of the grid occurs and the AC drive is powered down and restarted, whereas the motor is still running due to inertia. In this case, to recover control on the asynchronous motor, the AC drive must detect the current speed of the motor to avoid overcurrent, overvoltage, and even burn-out of the power transistor of the AC drive.</p> <p>2: Vector pre-excitation start (asynchronous motor) This mode is applicable to scenarios with large static load resistance that requires great starting torque. Pre-excited start can increase the starting torque. This mode is applicable only to the SVC and FVC modes of asynchronous motors. Before startup, the AC drive performs pre-excitation on the motor, which speeds up response of the motor and reduces the startup current. The timing diagram of this mode is the same as that of startup after DC braking.</p>

2.2.16 Setting the Startup Frequency (Optional)

Para. No.	Name	Default	Value Range	Description
F6-03	Startup frequency	0.00 Hz	0.00–10.00 Hz	This is the startup frequency for direct start of the AC drive. When the startup frequency is lower than the frequency reference, the AC drive stays in the standby state.
F6-04	Startup frequency hold time	0.0s	0.0–100.0s	The output frequency stays at the startup frequency for a period of time as specified by this parameter. At the expiry of this time, the output frequency will accelerate to the frequency reference.

2.2.17 Setting the S-curve (Optional)

Para. No.	Name	Default	Value Range	Description
F6-07	Acceleration/Deceleration mode	0	0: Linear acceleration/ deceleration 1: S-curve acceleration/ deceleration	This parameter specifies the frequency change mode in the AC drive start/stop process. 0: The output frequency increases or decreases linearly. 1: The output frequency increases or decreases according to the S-curve when the target frequency is changing dynamically. This mode is applicable to applications requiring supreme riding comfort and real-time fast response.
F6-08	Time proportion of S-curve at start	30.0%	0.0% to (100.0% – Value of F6-09)	The sum of the time proportion of S-curve at start (F6-08) and the time proportion of S-curve at end segment (F6-09) cannot exceed 100%.
F6-09	Time proportion of S-curve at end	30.0%	0.0% to (100.0% – Value of F6-08)	The sum of the time proportion of S-curve at start (F6-08) and the time proportion of S-curve at end (F6-09) cannot exceed 100%.

2.2.18 Setting Stop Parameters

Para. No.	Name	Default	Value Range	Description
F6-10	Stop mode	0	0: Decelerate to stop 1: Coast to stop	0: Decelerate to stop After the stop command takes effect, the AC drive reduces the output frequency based on the deceleration time and stops when the frequency decreases to zero. 1: Coast to stop After the stop command takes effect, the AC drive immediately stops output. Then, the motor coasts to stop following mechanical inertia.
F6-11	Starting frequency of DC braking at stop	0.00 Hz	0 to the maximum frequency (F0-10)	In a decelerate-to-stop process, the AC drive starts DC braking when the running frequency drops to this frequency.
F6-12	Waiting time of DC braking at stop	0.0s	0.0–100.0s	When the running frequency decreases to the starting frequency of DC braking at stop, the AC drive stops output and starts DC braking after this waiting time. Such delay is intended to prevent faults such as overcurrent from occurring when DC braking starts at a high speed.
F6-13	DC braking current at stop	0%	0% to 150%	A greater DC braking current at stop indicates a greater braking force. 100% corresponds to the rated motor current, with an upper limit being 80% of the rated current of the AC drive. You can use F6-34 to set the current upper limit. The maximum current upper limit can be set to 135% of the rated current of the AC drive.
F6-14	DC braking time at stop	0.0s	0.0–100.0s	This parameter specifies the hold time of DC braking. If it is set to 0, DC braking is disabled.

2.2.19 Setting AI (Optional)

Para. No.	Name	Default	Value Range	Description
F4-13	AI curve 1 minimum input	-10.00 V	-10.00 to the value of F4-15	<p>When the main frequency is set by analog input, each AI terminal, as a frequency source, supports five types of AI curves.</p> <p>The AI curve is used to set the mapping between the analog input voltage (or current) and the percentage with respect to the maximum frequency (F0-10). The x axis of this curve indicates the analog input voltage (or current), and the y axis indicates the percentage corresponding to analog input, that is, the percentage with respect to the maximum frequency (F0-10).</p> <p>Five types of AI curves are provided, where curves 1, 2, and 3 are two-point curves set by parameters F4-13 to F4-27. Curves 4 and 5 are four-point curves set by parameters A6-00 to A6-15.</p> <p>The two points on curves 1 to 3 are the minimum input point and maximum input point, respectively. F4-13 corresponds to the x axis of AI curve 1 minimum input, that is, the minimum analog input voltage (or current).</p>
F4-14	Percentage corresponding to AI curve 1 minimum input	-100.0%	-100.0% to +100.0%	F4-14 corresponds to the y axis of AI curve 1 minimum input, that is, the percentage corresponding to the minimum analog input.
F4-15	AI curve 1 maximum input	10.00 V	Value of F4-13 to 10.00 V	F4-15 corresponds to the x axis of AI curve 1 maximum input, that is, the maximum analog input voltage (or current).
F4-16	Percentage corresponding to AI curve 1 maximum input	100.0%	-100.0% to +100.0%	F4-16 corresponds to the y axis of AI curve 1 maximum input, that is, the percentage corresponding to the maximum analog input.

2.2.20 Setting AO (Optional)

Para. No.	Name	Default	Value Range	Description
F5-07	AO1 function selection	0	0: Running frequency 1: Frequency reference 2: Output current 3: Output torque 4: Output power 5: Output voltage 6: Pulse input (100.0% corresponds to 100.00 kHz) 7: AI1 8: AI2 9: AI3 10: Length 11: Count value 12: Communication 13: Motor speed 14: Output current (100.0% corresponds to 1000.0 A) 15: Output voltage (100.0% corresponds to 1000.0 V) 16: Output torque (directional) 19: Taper output 20: Roll diameter output 21: Tension output	0: Running frequency (100.0% corresponds to the maximum frequency (F0-10)) 1: Frequency reference 2: Output voltage (100.0% corresponds to 2 times the rated motor current) 3: Motor output current (100.0% corresponds to 2 times the rated motor torque) (absolute value, a percentage of the rated motor torque) 4: Output power (100.0% corresponds to 2 times the rated motor power) 5: Output voltage (100.0% corresponds to 1.2 times the rated motor voltage) 6: Pulse input (100.0% corresponds to 100.0 kHz) 7: AI1 (100.0% corresponds to 10 V) 8: AI2 (100.0% corresponds to 10 V) 9: AI3 (100.0% corresponds to 10 V) 10: Length (100.0% corresponds to the value of Fb-05) 11: Count value (100.0% corresponds to the value of Fb-08) 12: Communication (100.0% corresponds to AO communication) 13: Motor speed (100.0% corresponds to the maximum frequency (F0-10)) 14: Output current (100.0% corresponds to 1000.0 A) 15: Output voltage (100.0% corresponds to 1000.0 V) 16: Motor output torque (100.0% corresponds to 2 times the rated motor torque, 50.0% corresponds to 0, and 0 corresponds to minus 2 times the rated motor torque) (actual value, a percentage of the rated motor torque) 19: Taper output 20: Roll diameter (100.0% corresponds to the maximum roll diameter (B0-08)) 21: Tension output (100.0% corresponds to the maximum tension output (B1-02))

Para. No.	Name	Default	Value Range	Description
F5-08	AO2 function selection	1	0: Running frequency 1: Frequency reference 2: Output current 3: Output torque 4: Output power 5: Output voltage 6: Pulse input (100.0% corresponds to 100.0 kHz) 7: AI1 8: AI2 9: AI3 10: Length 11: Count value 12: Communication 13: Motor speed 14: Output current (100.0% corresponds to 1000.0 A) 15: Output voltage (100.0% corresponds to 1000.0 V) 16: Output torque (directional) 19: Taper output 20: Roll diameter output 21: Tension output	0: Running frequency (100.0% corresponds to the maximum frequency (F0-10)) 1: Frequency reference 2: Output voltage (100.0% corresponds to 2 times the rated motor current) 3: Motor output current (100.0% corresponds to 2 times the rated motor torque) (absolute value, a percentage of the rated motor torque) 4: Output power (100.0% corresponds to 2 times the rated motor power) 5: Output voltage (100.0% corresponds to 1.2 times the rated motor voltage) 6: Pulse input (100.0% corresponds to 100.0 kHz) 7: AI1 (100.0% corresponds to 10 V) 8: AI2 (100.0% corresponds to 10 V) 9: AI3 (100.0% corresponds to 10 V) 10: Length (100.0% corresponds to the value of Fb-05) 11: Count value (100.0% corresponds to the value of Fb-08) 12: Communication (100.0% corresponds to AO communication) 13: Motor speed (100.0% corresponds to the maximum frequency (F0-10)) 14: Output current (100.0% corresponds to 1000.0 A) 15: Output voltage (100.0% corresponds to 1000.0 V) 16: Motor output torque (100.0% corresponds to 2 times the rated motor torque, 50.0% corresponds to 0, and 0 corresponds to minus 2 times the rated motor torque) (actual value, a percentage of the rated motor torque) 19: Taper output 20: Roll diameter (100.0% corresponds to the maximum roll diameter (B0-08)) 21: Tension output (100.0% corresponds to the maximum tension output (B1-02))

2.2.21 Setting DI (Optional)

Para. No.	Name	Default	Value Range		Description
F4-00	DI1 function selection	1	0: No function	26: Counter reset	
F4-01	DI2 function selection	4	1: Forward run (FWD)	27: Length count input	
F4-02	DI3 function selection	9	2: Reverse run (REV)	28: Length reset	
F4-03	DI4 function selection	12	3: Three-wire control	29: Torque control inhibited	
F4-04	DI5 function selection	13	4: Forward jog (FJOG)	30: Pulse frequency input (applicable only to DI5)	
F4-05	DI6 function selection	0	5: Reverse jog (RJOG)	31: Reserved	
F4-06	DI7 function selection	0	6: Terminal (UP)	32: Immediate DC braking	
F4-07	DI8 function selection	0	7: Terminal (DOWN)	33: NC input of external fault	
F4-08	DI9 function selection	0	8: Coast to stop	34: Frequency modification enable	
F4-09	DI10 function selection	0	9: Fault reset (RESET)	35: PID action direction reversal	
			10: Running pause	36: External stop terminal 1	
			11: NO input of external fault	37: Command source switchover terminal 2	
			12: Multi-reference terminal 1	38: PID integral pause	
			13: Multi-reference terminal 2	39: Switchover between main frequency source X and preset frequency	
			14: Multi-reference terminal 3	40: Switchover between auxiliary frequency source Y and preset frequency	
			15: Multi-reference terminal 4	41: Motor selection terminal 1	
			16: Terminal 1 for acceleration/deceleration selection	42: Reserved	
			17: Terminal 2 for acceleration/deceleration selection	43: PID parameter switchover	
			18: Frequency source switchover	44: User-defined fault 1	
			19: UP/DOWN setting clear	45: User-defined fault 2	
			20: Command source switchover terminal 1	46: Speed control/Torque control switchover	
			21: Acceleration/Deceleration inhibited	47: Emergency stop	
			22: PID pause	48: External stop terminal 2	
			23: PLC state reset	49: Deceleration DC braking	
			24: Wobble pause	50: Clear the current running time	
			25: Counter input	51: Two-wire/Three-wire switchover	
				52: Reverse run inhibited	

0: No function

The DI terminal has no function.

1: Forward run

The terminal is used to set the AC drive to forward run. In two-wire mode 1 (F4-11 set to 0), activating the terminal sets the AC drive to forward run. In two-wire mode 2 (F4-11 set to 1), activating the terminal gives a running command.

2: Reverse run

The terminal is used to set the AC drive to reverse run. In three-wire mode 1 (F4-11 set to 2), activating the terminal sets the AC drive to reverse run. In three-wire mode 2 (F4-11 set to 3), activating the terminal sets the forward/reverse run direction.

3: Three-wire control

This function is available only when the AC drive runs in three-wire control mode. To use a terminal as the command source, set F4-11 (terminal control mode) to 2 (three-wire mode 1) or 3 (three-wire mode 2), and set this parameter to 3. The three-wire control modes include three-wire mode 1 and three-wire mode 2.

4: Forward jog (FJOG)

The terminal is used to set the AC drive to FJOG mode. In jog mode, the AC drive runs at low speed for a short time, which is typically used for maintenance and commissioning of field equipment.

5: Reverse jog (RJOG)

The terminal is used to set the AC drive to RJOG mode.

6: Terminal (UP)

Activating the terminal gives a frequency increase command when the frequency is set using a terminal. When the terminal is active, the effect is equivalent to holding down the increment key. When the terminal is inactive, the effect is equivalent to releasing the increment key.

7: Terminal (DOWN)

Activating the terminal gives a frequency decrease command when the frequency is set using a terminal. When the terminal is active, the effect is equivalent to holding down the decrement key. When the terminal is inactive, the effect is equivalent to releasing the decrement key.

8: Coast to stop

Activating the terminal gives a coast to stop command, upon receiving which the AC drive stops output immediately, allowing the load to stop following mechanical inertia. When the AC drive stops output, the motor is powered off, and the system enters free braking. Since the stop time is determined by the inertia of the system, this is also called inertia stop.

9: Fault reset (RESET) Activating the terminal resets the AC drive. This function is the same as that of the STOP/RES key on the operating panel. This function can remotely reset the AC drive upon a fault.

10: Running pause

When the terminal is active with this functions, the AC drive decelerates to stop, and the settings of all the running parameters, such as the PLC, wobble, and PID parameters, are saved. When the terminal is inactive, the AC drive resumes its running state as recorded.

11: NO input of external fault

When the terminal is active, the AC drive reports the Err15 alarm upon receiving an external signal.

12–15: Multi-reference terminals 1–4

Multi-reference is selected as the main frequency source. You can set the 16 states of the four terminals to 16 speeds or 16 other references. This function is applicable to applications where continuous adjustment of the AC drive running frequency is not required and only several frequency values are required.

16 and 17: Terminals 1 and 2 for acceleration/deceleration selection

Four groups of acceleration/deceleration time can be selected through combinations of four states of these two terminals.

The acceleration time is the time required by the AC drive to accelerate from zero frequency to the acceleration/deceleration time base frequency (F0-25). The deceleration time is the time required by the AC drive to decelerate from the acceleration/deceleration base frequency (F0-25) to zero frequency.

18: Frequency source switchover

The terminal is used to switch between input methods of the frequency reference. The frequency reference is set through F0-07 (final frequency reference setting selection).

19: UP/DOWN setting clear

With the main frequency set using the operating panel, activating the terminal clears the frequency value that is set using the increment or decrement key on the operating panel or the terminals UP and DOWN and resumes the main frequency specified by F0-08.

20: Command source switchover terminal 1

- With the command source set to terminal control (F0-02 set to 1), activating the terminal switches from terminal control to operating panel control.
- With the command source set to communication control (F0-02 set to 2), activating the terminal switches from communication control to operating panel control.

21: Acceleration/Deceleration inhibited

The terminal is used to keep the AC drive at the current running frequency regardless of changes of the external input frequency (unless a stop command is received).

22: PID pause

The terminal is used to suspend PID control temporarily, so that the AC drive keeps the current output frequency with no more PID tuning on the frequency source.

23: PLC state reset

The terminal is used to reset the AC drive to the initial state of simple PLC.

24: Wobble pause

In the wobble process, the terminal being active suspends the wobble function, so that the AC drive provides output at the central frequency.

25: Counter input

In the counting process, the terminal being active inputs the pulses counted by the counter.

26: Counter reset

In a counting process, the terminal being active resets the counter.

27: Length count input

In a fixed length process, the terminal being active inputs the length count.

28: Length reset

In a fixed length process, the terminal being active resets the length.

29: Torque control inhibited

When the terminal is active, the AC drive is switched from the torque control mode to the speed control mode. When the terminal is inactive, the AC drive resumes the torque control mode.

30: Pulse frequency input (applicable only to DI5)

This function must be selected when DI5 is used for pulse input.

32: Immediate DC braking

The terminal is used to set the AC drive to immediate DC braking. DC braking means that the AC drive outputs DC to the stator winding of the asynchronous motor to form a static magnetic field to set the motor to braking with energy consumption. In this state, the rotor cuts the static magnetic field to generate braking torque, which stops the motor quickly.

33: NC input of external fault

When the terminal is active, the AC drive reports the Err15 alarm upon receiving an external signal.

34: Frequency modification enable

When the terminal is active, frequency modification is enabled. When the terminal is inactive, frequency modification is disabled.

35: PID action direction reversal

The terminal is used to reverse the PID action direction specified by FA-03.

36: External stop terminal 1

If the command source is set to operating panel control (F0-02 is set to 0), the terminal is used to stop the AC drive. This function is the same as that of the STOP/RES key on the operating panel.

37: Command source switchover terminal 2

The terminal is used to switch the AC drive between terminal control and communication control.

- With the command source set to terminal control, the terminal being active switches the system to communication control.
- With the command source set to communication control, the terminal being active switches the system to terminal control.

38: PID integral pause

The terminal is used to suspend integral tuning of PID without disabling its proportional and derivative tuning.

39: Switchover between main frequency source X and preset frequency

The terminal is used to switch main frequency reference X to the preset frequency (F0-08).

40: Switchover between auxiliary frequency source Y and preset frequency

The terminal is used to switch auxiliary frequency reference Y to the preset frequency (F0-08).

41: Motor selection

The terminal is used for motor selection. When the terminal is active, motor 2 is selected. When the terminal is inactive, motor 1 is selected.

43: PID parameter switchover

When the PID parameter switchover condition is set to "Switchover by DI terminal" (FA-18 set to 1):

- The PID parameters are FA-05 to FA-07 (proportional gain Kp1, integral time Ti1, and derivative time Td1) when the terminal is inactive.
- The PID parameters are FA-15 to FA-17 (proportional gain Kp2, integral time Ti2, and derivative time Td2) when the terminal is active.

44: User-defined fault 1

The terminal is used to make the AC drive report the Err27 alarm and proceed according to the value of F9-49 (fault protection action selection).

45: User-defined fault 2

The terminal is used to make the AC drive report the Err28 alarm and proceed according to the value of F9-49 (fault protection action selection).

46: Speed control/Torque control switchover

The terminal is used to switch the AC drive between speed control and torque control.

- If A0-00 (speed/torque control mode) is set to 0, the torque control mode is used when the terminal is active, and the speed control mode is used when the terminal is inactive.
- If A0-00 (speed/torque control mode) is set to 1, the speed control mode is used when the terminal is active, and the torque control mode is used when the terminal is inactive.

47: Emergency stop

Upon an emergency, the AC drive decelerates to stop within the deceleration time for emergency stop specified by F8-55. In V/f control mode, if the deceleration time for emergency stop is 0s, the AC drive decelerates to stop within the minimum unit time. The terminal does not need to be kept in the closed state. Even if it stays closed only for a short moment, the AC drive will come to an emergency stop. Different from general deceleration, the emergency stop action prevents the AC drive from restarting even if the emergency stop input terminal is opened after the deceleration time for emergency stop expires and the run signal is still valid on the AC drive terminal. To restart the AC drive in this case, disconnect the running terminal and input the run command.

48: External stop terminal 2

The AC drive decelerates to stop regardless of the command source (operation panel, terminal, or communication control). In this mode, the deceleration time is fixed to deceleration time 4 (F8-08).

49: Deceleration DC braking

The AC drive decelerates to the DC braking frequency during stop (F6-11) before starting DC braking.

50: Clear the current running time

The terminal is used to clear the current running time of the AC drive.

- If the current running time is less than the value of F8-53 (current running time threshold, which is greater than 0), and the terminal is active in the process, the current running time is cleared.
- If the current running time is greater than the value of F8-53 (greater than 0), the current running time is not cleared regardless of whether the terminal is active.

51: Two-wire/Three-wire switchover The terminal is used to switch the AC drive between the two-wire control mode and three-wire control mode, specifically:

- to three-wire mode 1 from two-wire mode 1 (F4-11 set to 0).
-
- to three-wire mode 2 from two-wire mode 2 (F4-11 set to 1).
- to two-wire mode 1 from three-wire mode 1 (F4-11 set to 2)

- to two-wire mode 2 from three-wire mode 2 (F4-11 set to 3).

52: Reverse run inhibited

The terminal, when active, prohibits reverse run of the AC drive. Even if the reverse frequency is set, the AC drive will not run reversely but runs fast at 0 Hz. This function is the same as F8-13.

2.2.22 Setting DO (Optional)

Para. No.	Name	Default	Value Range		Description
F5-04	DO1 function selection	0	0: No output 1: AC drive running 2: Fault output (coast-to-stop fault) 3: Frequency level detection 1 4: Frequency reach 5: Zero-speed running (no output at stop) 6: Motor overload pre-warning 7: AC drive overload pre-warning 8: Set count value reach 9: Designated count value reach 10: Length reach 11: Simple PLC cycle completed 12: Accumulative running time reach 13: Frequency limited 14: Torque limited 15: Ready to run 16: AI1 > AI2 17: Frequency upper limit reach 18: Frequency lower limit reach (no output at stop) 19: Undervoltage 20: Communication 21: Reserved 22: Reserved	23: Zero-speed running 2 (having output at stop) 24: Accumulative power-on time reach 25: Frequency level detection 2 26: Frequency 1 reach 27: Frequency 2 reach 28: Current 1 reach 29: Current 2 reach 30: Timing duration reach 31: AI1 input limit exceeded 32: Load lost 33: Reverse running 34: Zero current state 35: IGBT temperature reach 36: Output current limit exceeded 37: Frequency lower limit reach (having output at stop) 38: Alarm (all faults) 39: Motor overtemperature 40: Current running time reach 41: Fault (coast-to-stop fault and no output when undervoltage)	
F5-05	Extension card DO2 output selection	4			See below.

Used to set the functions for the open collector output terminals (FMR).

0: No output

The DO terminal has no function.

1: AC drive running

The DO terminal outputs the ON signal when the AC drive is running with an output frequency, which can be zero.

2: Fault output (coast-to-stop fault)

The DO terminal outputs the ON signal when the AC drive stops due to a fault.

3: Frequency level detection 1

The DO terminal outputs the ON signal when the running frequency exceeds the frequency detection value and stops outputting the ON signal when the running frequency is lower than the result of the detection value minus the frequency detection hysteresis (FDT, which equals the product of the value of F8-19 multiplied by the value of F8-20).

4: Frequency reach

The DO terminal outputs the ON signal when the running frequency of the AC drive is within a particular range (Target frequency \pm Product of the value of F8-21 multiplied by the maximum frequency).

5: Zero-speed running (no output at stop)

The DO terminal outputs the ON signal when the AC drive is running with the output frequency being 0. The DO terminal outputs the OFF signal when the AC drive is stopped.

6: Motor overload pre-warning

When detecting that the motor load has exceeded the pre-warning threshold specified by F9-02 (overload pre-warning coefficient), the DO terminal outputs the ON signal before an overload protection action is taken.

7: AC drive overload pre-warning

The DO terminal outputs the ON signal 10s before an AC drive overload protection action.

8: Set count value reach

In a counting process, the DO terminal outputs the ON signal when the count reaches the value of Fb-08.

9: Designated count value reach

In a counting process, the DO terminal outputs the ON signal when the count reaches the value of Fb-09.

10: Length reach

In a fixed length process, the DO terminal outputs the ON signal when the detected length exceeds the value of Fb-05.

11: Simple PLC cycle completed

The DO terminal outputs a pulse signal with width of 250 ms when simple PLC completes one cycle.

12: Accumulative running time reach

The DO terminal outputs the ON signal when the accumulative running time of the AC drive exceeds the value of F8-17 (accumulative power-on time threshold).

13: Frequency limited

The DO terminal outputs the ON signal when the frequency reference rises above the upper limit or falls below the lower limit and the output frequency of the AC drive reaches the upper limit or lower limit.

14: Torque limited

The DO terminal outputs the ON signal when the output torque reaches the torque limit if the AC drive is in speed control mode.

15: Ready to run

The DO terminal outputs the ON signal if no exception occurs after the AC drive is powered on.

16: AI1 > AI2

The DO terminal outputs the ON signal when the value of AI1 is greater than that of AI2.

17: Frequency upper limit reach

The DO terminal outputs the ON signal when the running frequency reaches the upper limit (F0-12).

18: Frequency lower limit reach (no output at stop)

The DO terminal outputs the OFF signal regardless of whether the running frequency has reached the lower limit when F8-14, which specifies the running mode when the frequency reference is lower than the lower limit, is set to 1 (stop).

The DO terminal outputs the ON signal when F8-14, which specifies the running mode when the frequency reference is lower than the lower limit, is set to 0 (running at the lower limit frequency) or 2 (zero-speed running) and the running frequency has reached the lower limit.

19: Undervoltage

The DO terminal outputs the ON signal when the AC drive is in the undervoltage state.

20: Communication

Activation and deactivation of the terminal is controlled through the communication address 0x2001.

21: Reserved

22: Reserved

23: Zero-speed running 2 (having output at stop)

The DO terminal outputs the ON signal when the AC drive is running with the output frequency being 0. The DO terminal outputs the ON signal when the AC drive is stopped.

24: Accumulative power-on time reach

The DO terminal outputs the ON signal when the accumulative power-on time (F7-13) of the AC drive exceeds the accumulative power-on time threshold (F8-16).

25: Frequency level detection 2

The DO terminal outputs the ON signal when the running frequency exceeds the frequency detection value and stops outputting the ON signal when the running frequency is lower than the result of the detection value minus the frequency detection hysteresis, which equals the product of the value of F8-28 multiplied by the value of F8-29.

26: Frequency 1 reach

The DO terminal outputs the ON signal when the running frequency of the AC drive is within the frequency detection range specified by F8-30 (detection of frequency 1).

Frequency detection range: Value of F8-30 – Value of F8-31 x Value of F0-10 (maximum frequency) to Value of F8-30 + Value of F8-31 x Value of F0-10

27: Frequency 2 reach

The DO terminal outputs the ON signal when the running frequency of the AC drive is within the frequency detection range specified by F8-32 (detection of frequency 2).

Frequency detection range: Value of F8-32 – Value of F8-33 x Value of F0-10 (maximum frequency) to Value of F8-32 + Value of F8-33 x Value of F0-10

28: Current 1 reach

The DO terminal outputs the ON signal when the output current of the AC drive is within the current detection range specified by F8-38 (free reach current 1).

Current detection range: Value of F8-38 – Value of F8-39 x Value of F1-03 (rated motor current) to Value of F8-38 + Value of F8-39 x Value of F1-03

29: Current 2 reach

The DO terminal outputs the ON signal when the output current of the AC drive is within the current detection range specified by F8-40 (free reach current 2).

Current detection range: Value of F8-40 – Value of F8-41 x Value of F1-03 (rated motor current) to Value of F8-40 + Value of F8-41 x Value of F1-03

30: Timing duration reach

With the timing function (F8-42) enabled, the DO terminal outputs the ON signal when the current running time of the AC drive reaches the set timing duration. The timing duration is set using F8-43 and F8-44.

31: AI1 input limit exceeded

The DO terminal outputs the ON signal when the value of AI1 is greater than that of F8-46 (AI1 input voltage upper limit) or less than that of F8-45 (AI1 input voltage lower limit).

32: Load lost

The DO terminal outputs the ON signal when load of the AC drive is lost.

33: Reverse running

The DO terminal outputs the ON signal when the AC drive is in reverse run.

34: Zero current state

The DO terminal outputs the ON signal when the output current of the AC drive stays in the zero current range for longer than the zero current detection delay (F8-35). Zero current detection range: 0 to Value of F8-34 x Value of F1-03

35: IGBT temperature reach

The DO terminal outputs the ON signal when the IGBT heatsink temperature (F7-07) reaches the IGBT temperature threshold (F8-47).

36: Output current limit exceeded

The DO terminal outputs the ON signal when the output current of the AC drive stays higher than the output overcurrent threshold (F8-36) for longer than the output overcurrent detection delay (F8-37).

37: Frequency lower limit reach (having output at stop)

The DO terminal outputs the ON signal when the running frequency reaches the lower limit (F0-14), even when the AC drive is stopped.

38: Alarm (all faults)

The DO terminal outputs the ON signal when the AC drive is faulty and "Continue to run" is selected as the fault protection action.

For details about fault protection actions, see the description of parameters F9-47 to F9-50.

39: Motor overtemperature

The DO terminal outputs the ON signal when the motor temperature reaches the value of F9-58 (motor overtemperature pre-warning threshold). (You can check the motor temperature using U0-34.)

40: Current running time reach

The DO terminal outputs the ON signal when the current running time of the AC drive exceeds the value of F8-53 (current running time threshold).

41: Fault (coast-to-stop fault and no output when undervoltage)

The DO terminal outputs the ON signal when an AC drive fault (other than the undervoltage fault) occurs.

2.2.23 Setting Multi-speed References (Optional)

Para. No.	Name	Default	Value Range	Description
FC-00	Multi-reference 0	0.0%	-100.0% to +100.0%	<p>These are the frequency references for multiple speed segments. FC-00 to FC-15 correspond to a total of 16 frequency reference values for segments 0 to 15. A frequency reference value is calculated as a percentage of the maximum frequency instead of an absolute frequency value. 100% corresponds to the maximum frequency (F0-10). The four multi-reference terminals provided by the AC drive together have 16 states, corresponding to the 16 frequency reference values.</p> <p>The parameters in this group are applicable to applications where simple PLC is used as the main frequency source. In some industrial applications, the AC motor is only used to implement the functions of start/stop, timed per-segment speed regulation, and simple automatic forward and reverse running, with simple PLC to provide the control functions that are conventionally provided by an additional PLC. Simple PLC is typically used in industrial equipment such as mixture mixing and industrial washing machines.</p> <p>Parameters in this group are required when simple PLC is used as the main frequency (F0-03 set to 7).</p>
FC-01	Multi-reference 1			
FC-02	Multi-reference 2			
FC-03	Multi-reference 3			
FC-04	Multi-reference 4			
FC-05	Multi-reference 5			
FC-06	Multi-reference 6			
FC-07	Multi-reference 7			
FC-08	Multi-reference 8			
FC-09	Multi-reference 9			
FC-10	Multi-reference 10			
FC-11	Multi-reference 11			
FC-12	Multi-reference 12			
FC-13	Multi-reference 13			
FC-14	Multi-reference 14			
FC-15	Multi-reference 15			

2.2.24 Setting Relay Output (Optional)

Para. No.	Name	Default	Value Range		Description
F5-01	Extension card relay output function selection	0	0: No output	25: Frequency level detection FDT2 output	See below.
F5-02	Control board relay function selection (T/A1-T/B1-TC1)	2	1: AC Drive running 2: Fault output (stop at fault) 3: Frequency level detection FDT1 output 4: Frequency reach 5: Zero-speed running (no output at stop) 6: Motor overload pre-warning 7: AC drive overload pre-warning 8: Set count value reach 9: Designated count value reach 10: Length reach 11: PLC cycle completed 12: Accumulative running time reach 13: Frequency limited 14: Torque limited 15: Ready to run 16: AI1 > AI2 17: Frequency upper limit reach 18: Frequency lower limit reach (operation related) 19: Undervoltage output 20: Communication 21: Positioning completed 22: Proximity 23: Zero-speed running 2 (at stop) 24: Accumulative power-on time reach	26: Frequency 1 reach 27: Frequency 2 reach 28: Current 1 reach 29: Current 2 reach 30: Timing reach 31: AI1 input limit exceeded 32: Output load loss 33: Reverse running 34: Zero current state 35: IGBT temperature reach 36: Output current limit exceeded 37: Frequency lower limit reach (having output at stop) 38: Alarm output (direct output at fault or alarm) 39: Current over-temperature pre-warning 40: Current running time reach 41: Fault output 2 42: Fault output 3 43: Position lock succeeded 46: Brake release output	
F5-03	Control board relay function selection (T/A2-TC2)	0			

Used to set the functions for the open collector output terminals (FMR).

0: No output

The DO terminal has no function.

1: AC drive running

The DO terminal outputs the ON signal when the AC drive is running with an output frequency, which can be zero.

2: Fault output (coast-to-stop fault)

The DO terminal outputs the ON signal when the AC drive stops due to a fault.

3: Frequency level detection 1

The DO terminal outputs the ON signal when the running frequency exceeds the frequency detection value and stops outputting the ON signal when the running frequency is lower than the result of the detection value minus the frequency detection hysteresis (FDT, which equals the product of the value of F8-19 multiplied by the value of F8-20).

4: Frequency reach

The DO terminal outputs the ON signal when the running frequency of the AC drive is within a particular range (Target frequency \pm Product of the value of F8-21 multiplied by the maximum frequency).

5: Zero-speed running (no output at stop)

The DO terminal outputs the ON signal when the AC drive is running with the output frequency being 0. The DO terminal outputs the OFF signal when the AC drive is stopped.

6: Motor overload pre-warning

When detecting that the motor load has exceeded the pre-warning threshold specified by F9-02 (overload pre-warning coefficient), the DO terminal outputs the ON signal before an overload protection action is taken.

7: AC drive overload pre-warning

The DO terminal outputs the ON signal 10s before an AC drive overload protection action.

8: Set count value reach

In a counting process, the DO terminal outputs the ON signal when the count reaches the value of Fb-08.

9: Designated count value reach

In a counting process, the DO terminal outputs the ON signal when the count reaches the value of Fb-09.

10: Length reach

In a fixed length process, the DO terminal outputs the ON signal when the detected length exceeds the value of Fb-05.

11: Simple PLC cycle completed

The DO terminal outputs a pulse signal with width of 250 ms when simple PLC completes one cycle.

12: Accumulative running time reach

The DO terminal outputs the ON signal when the accumulative running time of the AC drive exceeds the value of F8-17 (accumulative power-on time threshold).

13: Frequency limited

The DO terminal outputs the ON signal when the frequency reference rises above the upper limit or falls below the lower limit and the output frequency of the AC drive reaches the upper limit or lower limit.

14: Torque limited

The DO terminal outputs the ON signal when the output torque reaches the torque limit if the AC drive is in speed control mode.

15: Ready to run

The DO terminal outputs the ON signal if no exception occurs after the AC drive is powered on.

16: AI1 > AI2

The DO terminal outputs the ON signal when the value of AI1 is greater than that of AI2.

17: Frequency upper limit reach

The DO terminal outputs the ON signal when the running frequency reaches the upper limit (F0-12).

18: Frequency lower limit reach (no output at stop)

The DO terminal outputs the OFF signal regardless of whether the running frequency has reached the lower limit when F8-14, which specifies the running mode when the frequency reference is lower than the lower limit, is set to 1 (stop).

The DO terminal outputs the ON signal when F8-14, which specifies the running mode when the frequency reference is lower than the lower limit, is set to 0 (running at the lower limit frequency) or 2 (zero-speed running) and the running frequency has reached the lower limit.

19: Undervoltage

The DO terminal outputs the ON signal when the AC drive is in the undervoltage state.

20: Communication

Whether the terminal is active or inactive is controlled by the communication address 0x2001.

21: Positioning completed

The DO terminal outputs the ON signal when positioning is completed.

22: Proximity

The DO terminal outputs the ON signal upon proximity.

23: Zero-speed running 2 (having output at stop)

The DO terminal outputs the ON signal when the AC drive is running with the output frequency being 0. The DO terminal outputs the ON signal when the AC drive is stopped.

24: Accumulative power-on time reach

The DO terminal outputs the ON signal when the accumulative power-on time (F7-13) of the AC drive exceeds the accumulative power-on time threshold (F8-16).

25: Frequency level detection 2

The DO terminal outputs the ON signal when the running frequency exceeds the frequency detection value and stops outputting the ON signal when the running frequency is lower than the result of the detection value minus the frequency detection hysteresis, which equals the product of the value of F8-28 multiplied by the value of F8-29.

26: Frequency 1 reach

The DO terminal outputs the ON signal when the running frequency of the AC drive is within the frequency detection range specified by F8-30 (detection of frequency 1).

Frequency detection range: Value of F8-30 – Value of F8-31 x Value of F0-10 (maximum frequency) to Value of F8-30 + Value of F8-31 x Value of F0-10

27: Frequency 2 reach

The DO terminal outputs the ON signal when the running frequency of the AC drive is within the frequency detection range specified by F8-32 (detection of frequency 2).

Frequency detection range: Value of F8-32 – Value of F8-33 x Value of F0-10 (maximum frequency) to Value of F8-32 + Value of F8-33 x Value of F0-10

28: Current 1 reach

The DO terminal outputs the ON signal when the output current of the AC drive is within the current detection range specified by F8-38 (free reach current 1).

Current detection range: Value of F8-38 – Value of F8-39 x Value of F1-03 (rated motor current) to Value of F8-38 + Value of F8-39 x Value of F1-03

29: Current 2 reach

The DO terminal outputs the ON signal when the output current of the AC drive is within the current detection range specified by F8-40 (free reach current 2).

Current detection range: Value of F8-40 – Value of F8-41 x Value of F1-03 (rated motor current) to Value of F8-40 + Value of F8-41 x Value of F1-03

30: Timing duration reach

With the timing function (F8-42) enabled, the DO terminal outputs the ON signal when the current running time of the AC drive reaches the set timing duration. The timing duration is set using F8-43 and F8-44.

31: AI1 input limit exceeded

The DO terminal outputs the ON signal when the value of AI1 is greater than that of F8-46 (AI1 input voltage upper limit) or less than that of F8-45 (AI1 input voltage lower limit).

32: Load lost

The DO terminal outputs the ON signal when load of the AC drive is lost.

33: Reverse running

The DO terminal outputs the ON signal when the AC drive is in reverse run.

34: Zero current state

The DO terminal outputs the ON signal when the output current of the AC drive stays in the zero current range for longer than the zero current detection delay (F8-35). Zero current detection range: 0 to Value of F8-34 x Value of F1-03

35: IGBT temperature reach

The DO terminal outputs the ON signal when the IGBT heatsink temperature (F7-07) reaches the IGBT temperature threshold (F8-47).

36: Output current limit exceeded

The DO terminal outputs the ON signal when the output current of the AC drive stays higher than the output overcurrent threshold (F8-36) for longer than the output overcurrent detection delay (F8-37).

37: Frequency lower limit reach (having output at stop)

The DO terminal outputs the ON signal when the running frequency reaches the lower limit (F0-14), even when the AC drive is stopped.

38: Alarm (all faults)

The DO terminal outputs the ON signal when the AC drive is faulty and "Continue to run" is selected as the fault protection action.

For details about fault protection actions, see the description of parameters F9-47 to F9-50.

39: Motor overtemperature

The DO terminal outputs the ON signal when the motor temperature reaches the value of F9-58 (motor overtemperature pre-warning threshold). (You can check the motor temperature using U0-34.)

40: Current running time reach

The DO terminal outputs the ON signal when the current running time of the AC drive exceeds the value of F8-53 (current running time threshold).

41: Fault output 2

The DO terminal outputs the ON signal when an AC drive fault (other than the undervoltage fault) occurs.

42: Fault output 3

The DO terminal outputs the ON signal when an AC drive fault occurs.

43: Position lock succeeded

The DO terminal outputs the ON signal when the number of offset pulses of position lock is less than the value of F6-25 and the AC is running with position lock.

46: Brake release output

The DO terminal outputs the ON signal in case of position lock during deceleration or when a running command is received and running is enabled.

2.3 Function Commissioning

2.3.1 PMVC Function Commissioning (Applicable Only to Synchronous Motors)

Commissioning process

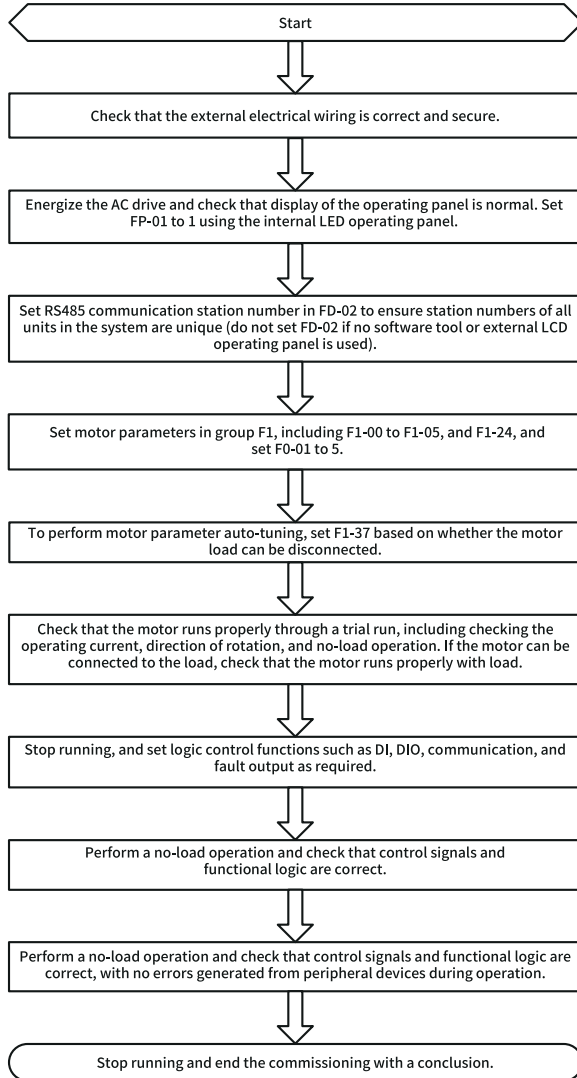

Figure 2-6 Commissioning flowchart

Commissioning procedure

1. Set F0-01 to 5 and F1-00 to 2.
2. Set the motor-related parameters F1-01 to F1-05 and set F1-24 (number of motor pole pairs).
3. Set F1-37 (Auto-tuning selection) to 12 (No-load dynamic auto-tuning) or 11 (Static auto-tuning).
4. After auto-tuning, set no-load trial run.
5. If low-speed load startup is required, set F3-01 (Torque boost).

Parameters

Para. No.	Name	Default	Value Range	Setpoint
F0-01	Motor 1 control mode	0	0: Sensorless vector control (SVC) 1: Feedback vector control (FVC) 2: V/f control 5: PMVC (applicable only to synchronous motors)	0
F1-00	Motor type selection	0	0: Common asynchronous motor 1: Variable frequency asynchronous motor 2: Synchronous motor	0
F1-01	Rated motor power	Model dependent	0.1–1000.0 kW	Model dependent
F1-02	Rated motor voltage	Model dependent	1–2000 V	Model dependent
F1-03	Rated motor current	Model dependent	0.1–6553.5 A	Model dependent
F1-04	Rated motor frequency	Model dependent	0.01–600.00 Hz	Model dependent
F1-05	Rated motor speed	Model dependent	1–65535 RPM	Model dependent
F1-20	Filter time constant (PMVC)	0.1	0.003–65.535	0.040
F1-21	Oscillation suppression gain (PMVC)	100	0–65535	0.100

Para. No.	Name	Default	Value Range	Setpoint
F1-24	Number of motor pole pairs	2	0–65535	1
F1-37	Auto-tuning selection	0	0: No auto-tuning 1: Static auto-tuning on partial parameters of asynchronous motor 2: Dynamic auto-tuning on all parameters of asynchronous motor 3: With-load auto-tuning on all parameters of asynchronous motor 4: Asynchronous motor inertia auto-tuning (only in FVC mode) 11: Static auto-tuning on partial parameters of synchronous motor (excluding back EMF) 12: No-load dynamic auto-tuning on all parameters of synchronous motor 13: Static auto-tuning on all parameters of synchronous motor (excluding the encoder installation angle) 14: Synchronous motor inertia auto-tuning (only in FVC mode)	0

3 Troubleshooting

3.1 Common Faults and Diagnosis

3.1.1 Display of Alarms and Faults

Upon exceptions, the AC drive stops output immediately, the fault indicator



blinks, and the contact of the fault relay acts. The operating panel of the

AC drive displays a fault code (example: E23.00), as shown in the following figure.

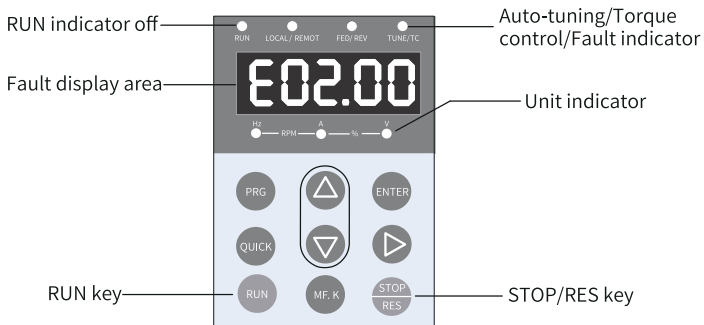



Figure 3-1 Display of faults



Do not repair or modify the AC drive by yourself. In case of any fault that cannot be rectified, contact the agent or Inovance for technical support.

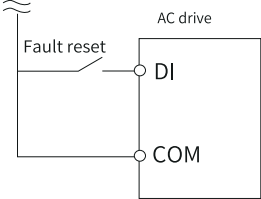
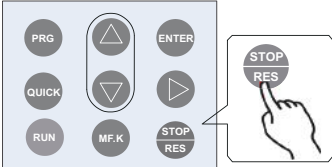
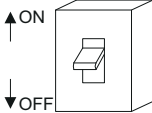
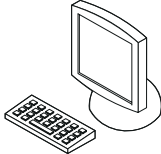

3.1.2 Restart upon Faults

Table 3-1 Restart methods upon faults

Stage	Solution	Description
When a fault occurs	Check the operating panel for detailed information about the last three faults, such as the fault time, fault type, and frequency, current, bus voltage, input/output terminal state, accumulative power-on time, and accumulative running time upon the faults.	View the information through F9-14 to F9-44. 
Before fault reset	Locate and rectify the fault cause based on the fault code displayed on the operating panel. Then reset to clear the fault.	-
During fault reset	1. Set any of F4-00 to F4-09 to 9 (fault reset).	
	2. Verify that F7-02 is set to 1 (default value), that is, the STOP/RES key is available in any operating mode.	Press the STOP/RES key on the operating panel. 
	3. Power off and then power on the AC drive for automatic reset. Disconnect the main circuit power supply and connect the power supply again after the display on the operating panel disappears.	
	4. Use a host controller for reset (for communication control mode). Verify that F0-02 is set to 2 (communication control mode) and write "7" to the communication address 2000H by using the host controller.	

3.1.3 Common Troubleshooting

Table 3-2 Symptoms and troubleshooting

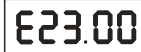
No.	Symptom	Possible Cause	Action
1	The display does not work upon power-on. 	The grid voltage is not input or too low.	Check the input power supply.
		The switched-mode power supply (SMPS) on the driver board of the AC drive is faulty.	Check whether the 24 V output voltage and 10 V output voltage on the control board are normal.
		The control board is disconnected from the driver board or the operating panel.	Re-connect the 8-conductor and 40-conductor flat cables.
		The pre-charge resistor of the AC drive is damaged.	Contact Inovance.
		The control board or operating panel is faulty.	
		The rectifier bridge is damaged.	
2	"HC" is displayed upon power-on. 	The connection between the driver board and the control board is poor.	Re-connect the 8-conductor and 28-conductor flat cables.
		Related components on the control board are damaged.	Contact Inovance.
		The motor or motor cable is short-circuited to ground.	
		The Hall device is faulty.	
		The grid voltage is too low.	
3	"E23.00" is displayed upon power-on. 	The motor or motor cable is short-circuited to the ground.	Use a megger to measure the insulation resistance of the motor and motor cable.
		The AC drive is damaged.	Contact Inovance.

No.	Symptom	Possible Cause	Action
4	The display is normal upon power-on, but "HC" is displayed and the AC drive stops immediately after startup. <div style="text-align: center; margin-top: 10px;">  </div>	The fan is damaged, or locked-rotor occurs.	Replace the damaged fan.
		Wiring of any external control terminals is short-circuited.	Rectify the short circuit fault.
5	E14.00 (IGBT overtemperature) is reported frequently.	The carrier frequency is set too high.	Reduce the carrier frequency (F0-15).
		The fan is damaged, or the air filter is blocked.	Replace the fan or clean the air filter.
		Devices (thermistor or other devices) inside the AC drive are damaged.	Contact Inovance.
6	The motor does not rotate when the AC drive is running.	The AC drive and motor are incorrectly connected.	Double check the connection between the AC drive and motor.
		Related AC drive parameters (motor parameters) are set incorrectly.	Restore the AC drive to factory settings and re-set the following parameters correctly:
			Encoder parameters and rated motor specifications (such as rated motor frequency and rated motor speed)
			F0-01 and F0-02
		F3-01 for heavy-load start in V/f control mode	
		The connection between the driver board and the control board is poor.	Re-connect the cables and ensure secure wiring.
The driver board is faulty.	Contact Inovance.		
7	DI terminals are inactive.	Related parameters are set incorrectly.	Check and set parameters in group F4 again.
		External signals are incorrect.	Re-connect external signal cables.
		The jumper across OP and +24 V becomes loose.	Check and ensure secure connection of the jumper across OP and +24V.
		The control board is faulty.	Contact Inovance.

No.	Symptom	Possible Cause	Action
8	In FVC mode, the motor cannot speed up.	The encoder is faulty.	Replace the encoder and double check the wiring.
		The encoder wiring is incorrect or in poor contact.	Reconnect the encoder to ensure good contact.
		The PG card is faulty.	Replace the PG card.
		The driver board is faulty.	Contact Inovance.
9	The AC drive detects overcurrent and overvoltage frequently.	Motor parameters are incorrectly set.	Set motor parameters or perform motor auto-tuning again.
		The acceleration/ deceleration time is improper.	Set proper acceleration/ deceleration time.
		The load fluctuates.	Contact Inovance.
10	E17.00 is reported upon power-on or during running.	The soft start contactor is not closed.	Check whether the contactor cable is loose.
			Check whether the contactor is faulty.
			Check whether 24 V power supply of the contactor is faulty.
			Contact Inovance.
11	The motor coasts to stop, or braking is disabled during deceleration or deceleration to stop.	The encoder is disconnected, or overvoltage stall protection is enabled.	Check the encoder wiring in FVC mode (F0-01 is set to 1).
			If a braking resistor is configured, set F3-23 to 0.

3.1.4 Troubleshooting During Trial Run in Different Control Modes

- SVC mode (F0-01 set to 0 (default))

This mode is used to control the speed and torque of motor in scenarios without an encoder for speed feedback. In this control mode, motor auto-tuning is required to obtain motor-related parameters.

Table 3-3 Troubleshooting in SVC mode

Problem	Action
Overload or overcurrent reported during motor startup	Set motor parameters F1-01 to F1-05 according to motor nameplate. Perform motor auto-tuning (by setting F1-37). Dynamic auto-tuning on all parameters of the motor is preferred when possible.
Slow torque or speed response and motor vibration at frequencies below 5 Hz	In the case of slow motor torque and speed response, increase the value of F2-00 in increments of 10 or decrease the value of F2-01 in increments of 0.05. In the case of motor vibration, decrease the value of F2-00 and increase the value of F2-01.
Slow torque or speed response and motor vibration at frequencies above 5 Hz	In the case of slow motor torque and speed response, increase the value of F2-03 in increments of 10 or decrease the value of F2-04 in increments of 0.05. In the case of motor vibration, decrease the value of F2-03 and increase the value of F2-04.
Low speed accuracy	In the case of excessive speed deviation during with-load running, increase the value of F2-06 in increments of 10%.
Obvious speed fluctuation	In the case of abnormal motor speed fluctuation, increase the value of A9-05 in increments of 0.001s.
Loud motor noise	Increase the value of F0-15 in increments of 1.0 kHz. Note that an increase in the carrier frequency will result in an increase in the leakage current of the motor.
Insufficient motor torque	Check whether the torque upper limit is set too low. If yes, increase the value of F2-10 in speed control mode or increase the torque reference in torque control mode.

- FVC mode (F0-01 set to 1)

This mode is applicable to scenarios with an encoder for speed feedback. In this mode, you need to set the encoder pulses per revolution, encoder type and encoder direction correctly and perform auto-tuning on motor parameters.

Table 3-4 Troubleshooting in FVC mode

Problem	Action
Overload or overcurrent reported during motor startup	Set the encoder pulses per revolution, encoder type, and signal direction correctly.
Overload or overcurrent reported during motor rotation	Set motor parameters F1-01 to F1-05 according to motor nameplate. Perform motor auto-tuning (by setting F1-37). Dynamic auto-tuning on all parameters of the motor is preferred when possible.

Problem	Action
Slow torque or speed response and motor vibration at frequencies below 5 Hz	In the case of slow motor torque and speed response, increase the value of F2-00 in increments of 10 or decrease the value of F2-01 in increments of 0.05. In the case of motor vibration, decrease the values of F2-00 and F2-01.
Slow torque or speed response and motor vibration at frequencies above 5 Hz	In the case of slow motor torque and speed response, increase the value of F2-03 in increments of 10 or decrease the value of F2-04 in increments of 0.05. In the case of motor vibration, decrease the values of F2-03 and F2-04.
Obvious speed fluctuation	In the case of abnormal motor speed fluctuation, increase the value of F2-07 in increments of 0.001s.
Loud motor noise	Increase the value of F0-15 in increments of 1.0kHz. Note that an increase in the carrier frequency will result in an increase in the leakage current of the motor.
Insufficient motor torque	Check whether the torque upper limit is set too low. If yes, increase the value of F2-10 in speed control mode or increase the torque reference in torque control mode.

- V/f control mode (F0-01 set to 2)

This mode is applicable to scenarios without an encoder for speed feedback. You need to set rated motor voltage and rated motor frequency only because this mode is not sensitive to motor parameters.

Table 3-5 Troubleshooting in V/f control mode

Problem	Action
Motor oscillation during running	Decrease the value of F3-11 in increments of 5. The minimum value is 5.
Overcurrent during high-power startup	Decrease the value of F3-01 in increments of 0.5%.
High current during running	Set the rated motor voltage (F1-02) and rated motor frequency (F1-04) correctly. Decrease the value of F3-01 in increments of 0.5%.
Loud motor noise	Increase the value of F0-15 in increments of 1.0kHz. Note that an increase in the carrier frequency will result in an increase in the leakage current of the motor.
Overvoltage reported during deceleration or sudden removal of heavy loads	Verify that the overvoltage stall selection (F3-23) is enabled. Increase the overvoltage stall gain (F3-24/F3-25; default value: 30) in increments of 10 (the maximum value is 100). Decrease the value of F3-22 (default value: 770 V) in increments of 10 V (the minimum value is 700 V).
Overcurrent reported during acceleration or sudden connection of heavy loads	Increase the value of F3-20 (default value: 20) in increments of 10 (the maximum value is 100). Decrease the value of F3-18 (default value: 150%) in increments of 10% (the minimum value is 50%).

3.2 List of Fault Codes

The following faults may occur during use of the AC drive. Rectify the faults by taking actions described in the following table.

Table 3-6 Fault codes

Fault Name	Display	Possible Cause	Action
Overcurrent during acceleration	E02.00	Grounded or short-circuited output circuit of the AC drive	Check whether the motor or relay contactor is short-circuited.
		Auto-tuning missing in SVC or FVC control mode	Set motor parameters according to the motor nameplate and perform motor auto-tuning.
		Excessively short acceleration time	Increase the acceleration time (F0-17).
		Inappropriate overcurrent stall suppression	Ensure that overcurrent stall suppression (F3-19) is enabled. If the value of F3-18 (overcurrent stall suppression level) is too large, adjust it to a level between 120% and 160%. If the value of F3-20 (overcurrent stall suppression gain) is too small, adjust it to a level between 20 and 40.
		Inappropriate customized torque boost or V/f curve	Adjust the customized torque boost or V/f curve.
		Startup of an already running motor	Use flying start or restart the motor.
		External interference to the AC drive	View the fault records to check whether the fault current ever reached the overcurrent suppression level (F3-18). If not, check for external interference source. If no external interference source is found, consider damages to the driver board or Hall device and contact Inovance for replacement.
Overcurrent during deceleration	E03.00	Grounded or short-circuited output circuit of the AC drive	Check whether the motor is short-circuited or open-circuited.
		Auto-tuning missing in SVC or FVC control mode	Set motor parameters according to the motor nameplate and perform motor auto-tuning.
		Excessively short deceleration time	Increase the deceleration time (F0-18).
		Inappropriate overcurrent stall suppression	Ensure that overcurrent stall suppression (F3-19) is enabled. If the value of F3-18 (overcurrent stall suppression level) is too large, adjust it to a level between 120% and 150%. If the value of F3-20 (overcurrent stall suppression gain) is too small, adjust it to a level between 20 and 40.
		Missing braking unit or braking resistor	Install a braking unit and a braking resistor.
		External interference to the AC drive	View the fault records to check whether the fault current ever reached the overcurrent suppression level (F3-18). If not, check for external interference source. If no external interference source is found, consider damages to the driver board or Hall device and contact Inovance for replacement.

Fault Name	Display	Possible Cause	Action
Overcurrent during operation at constant speed	E04.00	Grounded or short-circuited output circuit of the AC drive	Check whether the motor is short-circuited or open-circuited.
		Auto-tuning missing in SVC or FVC control mode	Set motor parameters according to the motor nameplate and perform motor auto-tuning.
		Inappropriate overcurrent stall suppression	Ensure that overcurrent stall suppression (F3-19) is enabled. If the value of F3-18 (overcurrent stall suppression level) is too large, adjust it to a level between 120% and 150%. If the value of F3-20 (overcurrent stall suppression gain) is too small, adjust it to a level between 20 and 40.
		Inadequate power rating of the AC drive	If the running current exceeds the rated motor current or rated output current of the AC drive during stable running, replace the AC drive with one with a higher power rating.
		External interference to the AC drive	View the fault records to check whether the fault current ever reached the overcurrent suppression level (F3-18). If not, check for external interference source. If no external interference source is found, consider damages to the driver board or Hall device and contact Inovance for replacement.
Overvoltage during acceleration	E05.00	High input grid voltage	Adjust the voltage to the normal range.
		External force driving the motor during acceleration	Cancel the external force or install a braking resistor. If the value of F3-26 (frequency rise threshold during overvoltage suppression) is too small, adjust it to a level between 5 Hz to 15 Hz when an external force drives the motor.
		Inappropriate overvoltage suppression	Ensure that overvoltage suppression (F3-23) is enabled. If the value of F3-22 (overvoltage suppression) is too large, adjust it to a level between 700 V and 770 V. If the value of F3-24 (frequency gain for overvoltage suppression) is too small, adjust it to a level between 30 and 50.
		Missing braking unit or braking resistor	Install a braking unit and a braking resistor.
		Excessively short acceleration time	Increase the acceleration time.

Fault Name	Display	Possible Cause	Action
Overvoltage during deceleration	E06.00	Inappropriate overvoltage suppression	<p>Ensure that overvoltage suppression (F3-23) is enabled.</p> <p>If the value of F3-22 (overvoltage suppression) is too large, adjust it to a level between 700 V and 770 V.</p> <p>If the value of F3-24 (frequency gain for overvoltage suppression) is too small, adjust it to a level between 30 and 50.</p>
		External force driving the motor during deceleration	<p>Cancel the external force or install a braking resistor.</p> <p>If the value of F3-26 (frequency rise threshold during overvoltage suppression) is too small, adjust it to a level between 5 Hz to 15 Hz when an external force drives the motor.</p>
		Excessively short deceleration time	<p>Increase the deceleration time.</p>
		Missing braking unit or braking resistor	<p>Install a braking unit and a braking resistor.</p>
Overvoltage during operation at constant speed	E07.00	Inappropriate overvoltage suppression	<p>Ensure that overvoltage suppression (F3-23) is enabled.</p> <p>If the value of F3-22 (overvoltage suppression) is too large, adjust it to a level between 700 V and 770 V.</p> <p>If the value of F3-24 (frequency gain for overvoltage suppression) is too small, adjust it to a level between 30 and 50.</p>
		External force driving the motor during operation.	<p>Cancel the external force or install a braking resistor.</p> <p>If the value of F3-26 (frequency rise threshold during overvoltage suppression) is too small, adjust it to a level between 5 Hz to 15 Hz when an external force drives the motor.</p>
Undervoltage	E09.00	Instantaneous power failure	<p>Enable the power dip ride-through function (F9-59).</p>
		AC drive input voltage out of range	<p>Adjust the voltage to the normal range.</p>
		Abnormal bus voltage	<p>Contact Inovance for technical support.</p>
		Abnormal rectifier, IGBT driver board, or IGBT control board	<p>Contact Inovance for technical support.</p>

Fault Name	Display	Possible Cause	Action
AC drive overload	E10.00	Excessively heavy load or stalled motor	Reduce the load and check the motor and mechanical conditions.
		Inadequate power rating of the AC drive	Use an AC drive with a higher power rating.
		Auto-tuning missing in SVC or FVC control mode	Set motor parameters according to the motor nameplate and perform motor auto-tuning.
		Excessively high torque boost (F3-01) in V/f control mode	Decrease the value of F3-01 in increments of 1.0% or set F3-01 to 0 (automatic torque boost).
		Output phase loss on the AC drive	Check the output wiring of the AC drive.
Motor overload	E11.00	Inappropriate F9-01 (motor overload protection gain) setting.	Increase the value of F9-01 to prolong the motor overload time.
		Excessively heavy load or stalled motor	Reduce the load and check the motor and mechanical conditions.
Input phase loss	E12.00	Input phase loss	Ensure proper input RST cables and three-phase input voltage.
Output phase loss	E13.00	Motor fault	Check whether the motor is open-circuited.
		Abnormal lead wire connecting the AC drive to the motor	Rectify external faults.
		Unbalanced three-phase output of the AC drive during motor operation	Ensure proper functioning of the motor three-phase winding.
		Abnormal driver board or IGBT	Contact Inovance for technical support.
IGBT overtemperature	E14.00	High ambient temperature	Lower the ambient temperature.
		Blocked air filter	Clean the air filter.
		Damaged fan	Replace the damaged fan.
		Damaged IGBT thermistor	Contact Inovance for technical support.
		Damaged IGBT	Contact Inovance for technical support.
External fault	E15.01	External fault signal input to the multi-function DI terminal (normally open)	Rectify the external fault, and ensure that the mechanical condition allows restart (F8-18) and reset the operation.
	E15.02	External fault signal input to the multi-function DI terminal (normally closed)	Rectify the external fault, and ensure that the mechanical condition allows restart (F8-18) and reset the operation.

Fault Name	Display	Possible Cause	Action
Communication fault	E16.01	Modbus communication timeout	Ensure proper wiring of the RS485 communication cable. Ensure proper settings of Fd-04 and PLC communication cycle.
	E16.11	CANopen communication timeout	Ensure proper connection of the CAN communication cable. Check the values of Fd-15 to Fd-17 and confirm interference.
	E16.12	Inconsistency between PDO mapping configured for CANopen and the actual mapping	Check the PDO mapping of parameters in group AF.
	E16.21	CANlink heartbeat timeout	Ensure proper connection of the CAN communication cable. Check the values of Fd-15 to Fd-17 and confirm interference.
	E16.22	CANlink station number conflict	Change the value of Fd-13 to make CANlink station numbers different from each other.
Contactor fault	E17.00	Abnormal driver board and power supply	Replace the driver board or power supply board.
		Abnormal contactor	Replace the contactor.
		Abnormal lightning protection board	Replace the lightning protection board.
Damaged current sampling circuit	E18.00	Abnormal AC drive current sampling	Power on the main circuit.
			If the Hall sensor or sampling current circuit is damaged, contact Inovance.

Fault Name	Display	Possible Cause	Action
Motor auto-tuning fault	E19.02	Fault in auto-tuning on the synchronous motor magnetic pole position angle	Check for motor disconnection and output phase loss.
	E19.06	Fault in auto-tuning on the stator resistance	Check for motor disconnection. Set F1-03 (rated motor current) according to the motor nameplate.
	E19.07		
	E19.08		
	E19.09	Fault in auto-tuning on the asynchronous motor transient leakage inductance	Check for motor disconnection and output phase loss. Ensure that the motor is connected properly.
	E19.10		
	E19.11	Inertia auto-tuning fault	Set F1-03 (rated motor current) according to the motor nameplate. Increase the value of F2-43 (inertia auto-tuning and dynamic speed reference).
	E19.20	Timeout of auto-tuning on the synchronous motor no-load zero position angle	Check the Z feedback signal.
	E19.23	Fault in auto-tuning on the synchronous motor magnetic pole position	Set F1-03 (rated motor current) according to the motor nameplate. Decrease the value of F2-29 (synchronous motor initial angle detection current).
E19.24	Errors in auto-tuning on the asynchronous motor transient leakage inductance	Check whether the AC drive is rated at low power. If yes, use an AC drive with a proper power rating matching the motor power.	

Fault Name	Display	Possible Cause	Action
Encoder fault	E20.00	Encoder disconnected	Restore connection. Ensure proper wiring of the PG cable. Ensure proper wiring of the PG cable and power supply. Ensure consistency between the encoder pulses per revolution and the value of F1-27. Ensure proper wiring of the AB signal cable.
	E20.01	Encoder fault	
	E20.02	Encoder disconnected	
	E20.03	Encoder fault during synchronous motor no-load auto-tuning	
	E20.04	Encoder fault during synchronous motor no-load auto-tuning	
	E20.06	Encoder fault during synchronous motor with-load auto-tuning	
	E20.07	Encoder fault during synchronous motor no-load auto-tuning	
	E20.08	Encoder fault during synchronous motor no-load auto-tuning	
	E20.09	Encoder fault during synchronous motor auto-tuning	Check the encoder Z signal and wiring of the PG card.
	E20.10	Synchronous motor encoder fault	
	E20.11	The encoder is faulty during asynchronous motor FVC no-load auto-tuning.	Ensure that the encoder is properly connected. Ensure consistency between the encoder pulses per revolution and the value of F1-27.
	E20.12	Excessive deviation between the encoder feedback speed and the speed estimated by SVC	Check for encoder disconnection. Ensure proper setting of motor parameters. Ensure that motor auto-tuning is performed.
	E20.13	Resolver disconnected	Check the wiring of the resolver.
E20.17	23-bit encoder disconnected	Check the wiring of the resolver.	
EEPROM read/write fault	E21.01	EEPROM read/write abnormality	For communication write parameters, ensure proper mapping between parameters and RAM addresses. If the EEPROM chip is damaged, contact Invoiance to replace the control board.
	E21.02		
	E21.03		
	E21.04		

Fault Name	Display	Possible Cause	Action
Motor auto-tuning error	E22.00	Auto-tuned stator resistance out of range	Correctly set F1-02 (rated motor voltage) and F1-03 (rated motor current) in group F1 according to the motor nameplate.
	E22.01	Auto-tuned asynchronous motor rotor resistance out of range	Ensure that auto-tuning is performed after the motor stops.
	E22.02	Auto-tuned asynchronous motor no-load current and mutual inductance out of range If this alarm is reported, the AC drive calculates the mutual inductance and no-load current values based on known motor parameters. The calculated values may not be optimal values.	Set motor parameters in group F1 according to the motor nameplate. Ensure that the motor has no load before auto-tuning.
	E22.03	Auto-tuned synchronous motor back EMF out of range	Set F1-02 (rated motor voltage) according to the motor nameplate. Ensure that the motor has no load before auto-tuning.
	E22.04	Inertia auto-tuning fault	Set F1-03 (rated motor current) according to the motor nameplate.
Short-circuited to ground	E23.00	Motor short-circuited to ground	Check and, if necessary, replace the motor cables and motor.
Motor inter-phase short circuit	E24.00	Motor inter-phase short circuit	Check whether a two-phase short circuit occurs on the output UVW.
Rectifier fault	E25.00	Rectifier fault	Rectify corresponding faults, such as input phase loss and overtemperature. 1: Operation enabled 2: Incoming circuit breaker feedback 3: Auxiliary circuit breaker feedback 4: Leakage protection switch feedback If there is no feedback signal, an alarm is reported. 6: Inverter unit operation inhibited 7: Inverter unit coast-to-stop 8: User-defined inverter unit stop An alarm is reported in this mode.
Accumulative running time reach	E26.00	The accumulative running time has reached the reference value.	Clear the record through parameter initialization.
User-defined fault 1	E27.00	User-defined fault 1 signals input to the multi-function DI terminal	Reset.
		User-defined fault 1 signals input through the virtual I/O function	Reset.
User-defined fault 2	E28.00	User-defined fault 2 signals input to the multi-function DI terminal	Reset.
		User-defined fault 2 signals input through the virtual I/O function	Reset.

Fault Name	Display	Possible Cause	Action
Accumulative power-on time reach	E29.00	Accumulative power-on time reaching the reference value	Clear the record through parameter initialization.
Load lost	E30.00	Running current of the AC drive less than the value of F9-64	Check for load disconnection and mismatching between the values of F9-64 and F9-65 and actual working conditions.
PID feedback loss during operation	E31.00	PID feedback less than the value of FA-26	Check the PID feedback signals or set FA-26 to a proper value.
Pulse-by-pulse current limit fault	E40.00	Excessively heavy load or stalled motor	Reduce the load and check the motor and mechanical conditions.
		Inadequate power rating of the AC drive	Use an AC drive with a higher power rating.
Excessive speed deviation	E42.00	Incorrect setting of encoder parameters	Set encoder parameters properly.
		Missing auto-tuning on parameters	Perform motor parameter auto-tuning.
		Inappropriate setting of F9-69 and F9-70	Set the parameters correctly based on actual conditions.
Motor overspeed	E43.00	Incorrect setting of encoder parameters	Set encoder parameters properly.
		Missing auto-tuning on parameters	Perform motor parameter auto-tuning.
		Inappropriate setting of F9-67 and F9-68	Set the parameters correctly based on actual conditions.
Motor overtemperature	E45.00	Temperature sensor loosely connected	Check the wiring of the temperature sensor.
		High motor temperature	Increase the carrier frequency or take other heat dissipation measures to cool the motor.
		Excessively low value of F9-57 (motor overtemperature protection threshold)	Adjust the threshold to a level between 90°C and 100°C.
STO fault	E47.00	STO fault	Check whether the STO function (F8-54) is enabled.
			If the function is enabled, check whether the IGBT terminals STO1 and STO2 have 24 V input.
AC drive overtemperature	E60.00	High internal temperature of the AC drive	Replace the fan in the AC drive.
			Contact Inovance.
Braking transistor overload	E61.00	Excessively low resistance of the braking resistor	Use a braking resistor with higher resistance.
Braking transistor short circuit	E62.00	Braking transistor short circuit	Ensure proper functioning of the braking transistor.
			Check whether an external braking resistor is provided.
Low liquid level alarm	A63.00	Low liquid level of the water tank	Add coolant.

Troubleshooting

Fault Name	Display	Possible Cause	Action
Water cooling system fault	E64.00	Water-cooling system control unit fault	Reset. Replace the control unit.

4 Parameters

4.1 List of Function Parameters

If FP-00 is set to a non-zero value (password protection is enabled), the parameter menu is accessible in parameter mode and user-modification mode only after the correct password is entered. To disable password protection, set FP-00 to 0.

If a password is set to lock the operating panel, password authentication is required every time you access the parameter menu for reading or writing parameter values using the operating panel. During communication, the values of parameters (excluding parameters in groups FP and FF) can be read and written without password authentication.

Password protection is not available for the parameter menu in user-defined mode.

Groups F and A include standard function parameters. Group U includes the monitoring parameters. The following symbols are used in the parameter table:

- ☆: The parameter can be modified when the AC drive is in the stop or running state.
- ★: The parameter cannot be modified when the AC drive is in the running state.
- ●: The parameter represents the actual measured value and cannot be modified.
- *: The parameter is a factory parameter and can be set only by Inovance.

Para. No.	Name	Value Range	Default	Unit	Property
Group F0: Basic Parameters					
F0-00	G/P type display	1: G type (constant-torque load)	Model dependent	-	●
F0-01	Motor 1 control mode	0: Sensorless vector control (SVC) 1: Feedback vector control (FVC) 2: V/f control 3: Reserved 4: Reserved 5: PMWVC (applicable only to synchronous motors)	0	-	★
F0-02	Command source selection	0: Operating panel 1: Terminal 2: Communication	0	-	★

Para. No.	Name	Value Range	Default	Unit	Property
F0-03	Main frequency source X selection	0: Digital setting (preset frequency (F0-08) that can be changed by pressing UP/DOWN, non-retentive upon power failure) 1: Digital setting (preset frequency (F0-08) that can be changed by pressing UP/DOWN, retentive at power failure) 2: AI1 3: AI2 4: AI3 5: Pulse reference (DI5) 6: Multi-reference 7: Simple PLC 8: PID 9: Communication 10: Reserved	0	-	★
F0-04	Auxiliary frequency reference Y selection	0: Digital setting (preset frequency (F0-08) that can be changed by pressing UP/DOWN, non-retentive upon power failure) 1: Digital setting (preset frequency (F0-08) that can be changed by pressing UP/DOWN, retentive at power failure) 2: AI1 3: AI2 4: AI3 5: Pulse reference (DI5) 6: Multi-reference 7: Simple PLC 8: PID 9: Communication 10: Reserved	0	-	★
F0-05	Range selection of auxiliary frequency reference (Y) upon superposition	0: Relative to maximum frequency 1: Relative to main frequency X	0	-	☆
F0-06	Range value of auxiliary frequency reference (Y) upon superposition	0% to 150%	100	%	☆

Para. No.	Name	Value Range	Default	Unit	Property
F0-07	Final frequency reference setting selection	Ones (position): 0: Main frequency reference X 1: Main and auxiliary operation result (based on tens position) 2: Switchover between main frequency X and auxiliary frequency Y 3: Switchover between main frequency X and the main and auxiliary operation result 4: Switchover between auxiliary frequency Y and the main and auxiliary operation result Tens (position): 0: Main + Auxiliary 1: Main – Auxiliary 2: Max. (main, auxiliary) 3: Min. (main, auxiliary) 4: Main x Auxiliary	0	-	☆
F0-08	Preset frequency	0.00 to the maximum frequency (F0-10)	50.00 Hz	Hz	☆
F0-09	Running direction selection	0: Default direction 1: Opposite to the default direction	0	-	☆
F0-10	Maximum frequency	50.00–599.00 Hz	50.00 Hz	Hz	★
F0-11	Source of frequency upper limit	0: Frequency upper limit (F0-12) 1: AI1 2: AI2 3: AI3 4: Pulse reference (DI5) 5: Communication 6: Multi-speed reference	0	-	★
F0-12	Frequency upper limit	Frequency reference lower limit (F0-14) to the maximum frequency (F0-10)	50.00 Hz	Hz	☆
F0-13	Frequency upper limit offset	0.00 Hz to the maximum frequency (F0-10)	0.00 Hz	Hz	☆
F0-14	Frequency lower limit	0.00 Hz to the frequency upper limit (F0-12)	0.00 Hz	Hz	☆
F0-15	Carrier frequency	0.8–16.0 kHz	Model dependent	kHz	☆
F0-16	Carrier frequency adjusted with temperature	0: No 1: Yes	1	-	☆
F0-17	Acceleration time 1	0.0–6500.0s	20.0s	s	☆
F0-18	Deceleration time 1	0.0–6500.0s	20.0s	s	☆
F0-19	Acceleration/ Deceleration time unit	0: 1s 1: 0.1s 2: 0.01s	1	-	★

Parameters

Para. No.	Name	Value Range	Default	Unit	Property
F0-21	Offset frequency of auxiliary frequency source upon superposition	0 to value of F0-10	0.00 Hz	Hz	☆
F0-22	Frequency reference resolution	1: 0.1 Hz 2: 0.01 Hz	2 Hz	Hz	★
F0-23	Retentive memory for digital setting of frequency upon power off	0: Disabled 1: Enabled	0	-	☆
F0-25	Acceleration/ Deceleration time base frequency	0: Maximum frequency (F0-10) 1: Target frequency 2: 100 Hz	0	-	★
F0-26	Base frequency for UP/ DOWN modification during running	0: Running frequency 1: Target frequency	0	-	★
F0-27	Main frequency coefficient	0.00% to 100.00%	10.00%	%	☆
F0-28	Auxiliary frequency coefficient	0.00% to 100.00%	10.00%	%	☆
Group F1: Motor 1 Parameters					
F1-00	Motor type selection	0: Common asynchronous motor 1: Variable frequency asynchronous motor 2: Synchronous motor	0	-	★
F1-01	Rated motor power	0.1–1000.0 kW	Model dependent	kW	★
F1-02	Rated motor voltage	1–2000 V	Model dependent	V	★
F1-03	Rated motor current	0.01–655.35 A (power: ≤ 55 kW) 0.1–6553.5 A (power: > 55 kW)	Model dependent	A	★
F1-04	Rated motor frequency	0.01–600.00 Hz	Model dependent	Hz	★
F1-05	Rated motor speed	1–65535 RPM	Model dependent	RPM	★
F1-06	Asynchronous/ Synchronous motor stator resistance	0.001–65.535 Ω (power: ≤ 55 kW) 0.0001–6.5535 Ω (power: > 55 kW)	Model dependent	Ω	★
F1-07	Asynchronous motor rotor resistance	0.001 (power: ≤ 55 kW) 0.0001 (power: > 55 kW)	Model dependent	Ω	★
F1-08	Asynchronous motor leakage inductance	0.01–655.35 mH (power: ≤ 55 kW) 0.001–65.535 mH (power: > 55 kW)	Model dependent	mH	★
F1-09	Asynchronous motor mutual inductance	0.1–6553.5 mH (power: ≤ 55 kW) 0.01–655.35 mH (power: > 55 kW)	Model dependent	mH	★

Para. No.	Name	Value Range	Default	Unit	Property
F1-10	Asynchronous motor no-load current	0.1–6553.5 A (the maximum current is specified by F1-03)	Model dependent	A	★
F1-11	Asynchronous motor core saturation coefficient 1	50.0% to 100.0%	86.0%	%	☆
F1-12	Asynchronous motor core saturation coefficient 2	100.0% to 150.0%	130.0%	%	☆
F1-13	Asynchronous motor core saturation coefficient 3	100.0% to 170.0%	140.0%	%	☆
F1-14	Asynchronous motor core saturation coefficient 4	100.0% to 180.0%	150.0%	%	☆
F1-17	Synchronous motor axis D inductance	0.01–655.35 mH (power: ≤ 55 kW) 0.001–65.535 mH (power: > 55 kW)	Model dependent	mH	★
F1-18	Synchronous motor axis Q inductance	0.01–655.35 mH (power: ≤ 55 kW) 0.001–65.535 mH (power: > 55 kW)	Model dependent	mH	★
F1-19	Synchronous motor back EMF coefficient	0.0–6553.5 V	Model dependent	V	★
F1-20	Filter time constant (PMVVC)	0.003% to 65.535%	0.100 V	%	☆
F1-21	Oscillation suppression gain (PMVVC)	0–65535	100	-	☆
F1-23	Percentage of the frictional moment	0.00% to 100.00%	0.00%	%	★
F1-24	Number of motor pole pairs	0–65535	2	-	☆
F1-26	Auto-tuning direction (inertia auto-tuning and synchronous motor auto-tuning)	0: Reverse run 1: Forward run	1	-	★
F1-27	Encoder pulses per revolution	1–20000	1024	-	★
F1-28	Encoder type	0: ABZ incremental encoder 1: 23-bit encoder 2: Resolver	1	-	★
F1-29	PG signal filter	0: Non-adaptive filter 1: Adaptive filter 2: Fixed interlock 3: Automatic interlock	1	-	★
F1-30	Encoder wiring flag	Ones (position): AB signal direction or rotational direction Tens (position): Reserved	0	-	★
F1-31	Encoder zero position angle	0.0° to 359.9°	0.0°	°	★

Parameters

Para. No.	Name	Value Range	Default	Unit	Property
F1-32	Motor gear ratio numerator	1-65535	1	-	★
F1-33	Motor gear ratio denominator	1-65535	1	-	★
F1-34	Number of pole pairs of resolver	1-32	1	-	★
F1-36	PG open circuit detection	0: Disabled 1: Enabled	1	-	★
F1-37	Auto-tuning selection	0: No auto-tuning 1: Static auto-tuning on partial parameters of the asynchronous motor 2: Dynamic auto-tuning on all parameters of the asynchronous motor 3: With-load auto-tuning on all parameters of the asynchronous motor 4: Asynchronous motor inertia auto-tuning (only in FVC mode) 11: Static auto-tuning on partial parameters of the synchronous motor (excluding back EMF) 12: No-load dynamic auto-tuning on all parameters of the synchronous motor 13: Static auto-tuning on all parameters of the synchronous motor (excluding the encoder installation angle) 14: Synchronous motor inertia auto-tuning (only in FVC mode)	0	-	★
Group F2: Motor 1 Vector Control Parameters					
F2-00	Low-speed speed loop Kp	1-200	30 (asynchronous motor) or 20 (synchronous motor)	-	☆
F2-01	Low-speed speed loop Ti	0.001-10.000s	0.500s	s	☆
F2-02	Switchover frequency 1	0.00 to switchover frequency 2 (F2-05)	5.00 Hz	Hz	☆
F2-03	High-speed speed loop Kp	1-200	20	-	☆
F2-04	High-speed speed loop Ti	0.001-10.000s	1.000s	s	☆
F2-05	Switchover frequency 2	Value of F2-02 to the maximum frequency	10.00 Hz	Hz	☆
F2-06	VC slip compensation gain	50% to 200%	100%	%	☆
F2-07	Speed loop feedback filter time	0.000-0.100s	0.004s	s	☆

Para. No.	Name	Value Range	Default	Unit	Property
F2-09	Torque upper limit source in speed control (motoring)	0: Digital setting (F2-10) 1: AI1 2: AI2 3: AI3 4: Pulse reference (DI5) 5: Communication 6: Min. (AI1, AI2) 7: Max. (AI1, AI2)	0	-	☆
F2-10	Digital setting of torque upper limit in speed control (motoring)	0.0% to 200.0%	150.0%	%	☆
F2-11	Torque upper limit source in speed control (generating)	0: Digital setting (F2-10) 1: AI1 2: AI2 3: AI3 4: Pulse reference (DI5) 5: Communication 6: Min. (AI1, AI2) 7: Max. (AI1, AI2) 8: Digital setting (F2-12)	0	-	☆
F2-12	Torque upper limit settings in speed control (generating)	0.0% to 200.0%	150.0%	%	☆
F2-13	Low-speed current loop Kp adjustment	0.1–10.0	1.0	-	☆
F2-14	Low-speed current loop Ki adjustment	0.1–10.0	1.0	-	☆
F2-15	High-speed current loop Kp adjustment	0.1–10.0	1.0	-	☆
F2-16	High-speed current loop Ki adjustment	0.1–10.0	1.0	-	☆
F2-17	Speed loop Kp upon zero speed lock	1–100	30	-	☆
F2-18	Speed loop Ti upon zero speed lock	0.001–10.000s	0.500s	s	☆
F2-19	Inertia compensation gain	1–200	1	-	☆
F2-20	Speed loop switchover frequency upon zero speed lock	0 to value of F2-02	0.05 Hz	Hz	☆
F2-21	Maximum output voltage coefficient	100% to 110%	100	-	☆
F2-23	Zero speed lock	0: Disabled 1: Enabled	0	-	★

Parameters

Para. No.	Name	Value Range	Default	Unit	Property
F2-24	Overvoltage suppression Kp in vector control mode	0–1000	40	-	☆
F2-25	Acceleration compensation gain	0–200	0	-	●
F2-26	Acceleration rate compensation filter time	0–500	10	-	●
F2-27	Overvoltage suppression in vector control mode	0: Disabled 1: Enabled	1	-	☆
F2-28	Cut-off frequency of torque filter reference	50–1000 Hz	500 Hz	Hz	☆
F2-29	Synchronous motor initial angle detection current	50–180	80	-	☆
F2-30	Speed loop parameter auto-calculation	0: Disabled 1: Enabled	0	-	★
F2-31	Expected speed loop bandwidth (high speed)	0–3 Hz	0 Hz	Hz	☆
F2-32	Expected speed loop bandwidth (low speed)	1–10000 Hz	100 Hz	Hz	☆
F2-33	Expected speed loop bandwidth (zero speed)	1–10000 Hz	100 Hz	Hz	☆
F2-34	Damping ratio of expected speed loop (unchanged generally)	0.100–65.000	1.000	-	☆
F2-35	System inertia (equivalent to the start time)	0.001–50.000s	Model dependent	s	★
F2-36	Motor inertia (kg x m ²)	0.001–50.000 kg x m ²	Model dependent	kg x m ²	★
F2-37	Inertia auto-tuning maximum frequency	20% to 100%	80%	%	★
F2-38	Inertia auto-tuning acceleration time	1.0–50.0s	10.0s	s	★
F2-39	Bandwidth 1 of speed loop dynamic optimization test	1.0–200.0 Hz	5.0 Hz	Hz	●
F2-40	Bandwidth 2 of speed loop dynamic optimization test	1.0–200.0 Hz	10.0 Hz	Hz	●
F2-41	Bandwidth 3 of speed loop dynamic optimization test	1.0–100.0 Hz	15.0 Hz	Hz	●

Para. No.	Name	Value Range	Default	Unit	Property
F2-42	Bandwidth 4 of speed loop dynamic optimization test	1.0–200.0 Hz	20.0 Hz	Hz	●
F2-43	Inertia auto-tuning and dynamic speed reference	0–100	30	-	★
F2-44	Rotor time constant check	0: Disabled 1: Enabled	0	-	●
F2-45	Torque amplitude of rotor time constant check	10% to 100%	30%	%	●
F2-46	Number of times of rotor constant check	1–6	3	-	●
F2-47	Inertia auto-tuning	0: Disabled 1: Enabled	0	-	★
F2-48	Speed loop bandwidth during inertia auto-tuning	0.1–100.0 Hz	10.0 Hz	Hz	★
F2-49	Back EMF calculation	0: Disabled 1: Enabled	1	-	●
F2-50	Inertia auto-tuning mode	0: Acceleration/Deceleration mode 1: Triangular wave mode	0	-	★
F2-51	Acceleration/Deceleration coefficient of inertia auto-tuning	0.1–10.0	1.0	-	★
F2-52	Decoupling control	0: Disabled 1: Enabled	0	-	★
F2-53	Power limit selection during generating	0: Disabled 1: Enabled	0	-	★
F2-54	Power limit during generating	0.0% to 200.0%	20.0%	%	★
F2-55	Flux closed loop and torque linearity optimization in FVC mode	Ones (position): Flux closed loop in torque control mode 0: Disabled 1: Enabled Tens (position): Flux closed loop in speed control mode 0: Disabled 1: Enabled Hundreds (position): Torque upper limit and torque linearity in speed control mode 0: Disabled 1: Enabled	10	-	★
F2-56	AC drive output current upper limit	0.0% to 170.0%	150.0	%	★

Parameters

Para. No.	Name	Value Range	Default	Unit	Property
Group F3: V/f Control Parameters					
F3-00	V/F curve setting	0: Linear V/f curve 1: Multi-point V/f curve 2: Square V/f curve 3: 1.2-power V/f curve 4: 1.4-power V/f curve 6: 1.6-power V/f curve 8: 1.8-power V/f curve 10: V/f complete separation mode 11: V/f half separation mode	0	-	★
F3-01	Torque boost	0.0% to 30.0% 0.0%: Automatic torque boost	Model dependent	%	☆
F3-02	Cutoff frequency of torque boost	0 to the maximum frequency	50.00 Hz	Hz	★
F3-03	Multi-point V/f frequency 1	0 to value of F3-05	0.00 Hz	Hz	★
F3-04	Multi-point V/f voltage 1	0.0% to 100.0%	0.0%	%	★
F3-05	Multi-point V/f frequency 2	F3-03 to F3-07	0.00 Hz	Hz	★
F3-06	Multi-point V/f voltage 2	0.0% to 100.0%	0.0%	%	★
F3-07	Multi-point V/f frequency 3	F3-05 to F1-04	0.00 Hz	Hz	★
F3-08	Multi-point V/f voltage 3	0.0% to 100.0%	0.0%	%	★
F3-09	V/f slip compensation gain	0.0% to 200.0%	0.0%	%	☆
F3-10	V/f overexcitation gain	0–200	64	-	☆
F3-11	V/f oscillation suppression gain	0–100	Model dependent	-	☆
F3-12	Oscillation suppression gain mode	0: Disabled 3: Enabled	3	-	★
F3-13	Voltage source for V/f separation	0: Digital setting (F3-14) 1: AI1 2: AI2 3: AI3 4: Pulse reference (DI5) 5: Multi-reference 6: Simple PLC 7: PID 8: Communication	0	-	☆
F3-14	Voltage digital setting for V/f separation	0 to value of F1-02	0 V	V	☆
F3-15	Voltage rise time of V/f separation	0.0–1000.0s	0.0s	s	☆
F3-16	Voltage decline time of V/f separation	0.0–1000.0s	0.0s	s	☆

Para. No.	Name	Value Range	Default	Unit	Property
F3-17	Stop mode selection for V/f separation	0: Frequency and voltage decline to 0 independently 1: Frequency declines after voltage declines to 0	0	-	★
F3-18	V/f overcurrent stall action current	50% to 200%	150%	%	★
F3-19	V/f overcurrent stall selection	0: Disabled 1: Enabled	1	-	★
F3-20	V/f overcurrent stall suppression gain	0–100	20	-	☆
F3-21	Compensation coefficient of V/f speed multiplying overcurrent stall action current	50% to 200%	50	-	★
F3-22	V/f overvoltage stall protective voltage	200.0–2000.0 V	770.0 V	V	★
F3-23	V/f overvoltage stall selection	0: Disabled 1: Enabled	1	-	★
F3-24	Frequency gain for V/f overvoltage stall suppression	0–100	30	-	☆
F3-25	Voltage gain for V/f overvoltage stall suppression	0–100	30	-	☆
F3-26	Frequency rise threshold during overvoltage stall	0–50 Hz	5	-	★
F3-27	Slip compensation time constant	0.1–10.0	0.5	-	☆
F3-28	V/f parameter auto-tuning inertia coefficient	0.00–10.00	0.10	-	★
F3-33	Online torque compensation gain	80–150	100	-	★
Group F4: Input Terminal Parameters					

Parameters

Para. No.	Name	Value Range	Default	Unit	Property
F4-00	DI1 function selection	0: No function 1: Forward run (FWD) 2: Reverse run (REV) 3: Three-wire control 4: Forward jog (FJOG) 5: Reverse jog (RJOG) 6: Terminal (UP) 7: Terminal (DOWN) 8: Coast to stop 9: Fault reset (RESET) 10: Running pause 11: NO input of external fault 12: Multi-reference terminal 1 13: Multi-reference terminal 2 14: Multi-reference terminal 3 15: Multi-reference terminal 4 16: Terminal 1 for acceleration/ deceleration selection 17: Terminal 2 for acceleration/ deceleration selection 18: Frequency source switchover 19: UP and DOWN setting clear (terminal, operation panel) 20: Command source switchover terminal 21: Acceleration/Deceleration inhibited 22: PID pause 23: PLC state reset 24: Wobble pause 25: Counter input (DIO1) 26: Counter reset 27: Length count input (DIO1) 28: Length reset 29: Torque control inhibited 30: Pulse input 31: Reserved 32: Immediate DC braking 33: NC input of external fault	1	-	★

Para. No.	Name	Value Range	Default	Unit	Property
(continued)	(continued)	34: Frequency modification enable 35: PID action direction reversal 36: External stop terminal 1 37: Command source switchover terminal 2 38: PID integral pause 39: Switchover between main frequency source X and preset frequency 40: Switchover between auxiliary frequency source Y and preset frequency 41: Motor selection 42: Position lock enabled 43: PID parameter switchover 44: User-defined fault 1 45: User-defined fault 2 46: Speed control/Torque control switchover 47: Emergency stop 48: External STOP terminal 2 49: Deceleration DC braking 50: Clear the current running time 51: Two-wire/three-wire control switchover 52: Electromagnetic shorting 53: Thickness overlaying 54: Roll diameter reset 55: Initial roll diameter 1 56: Initial roll 2 57: Pre-charge 58: Winding/Unwinding switchover 59: Winding diameter calculation disabled 60: Exit tension control 61: Terminal tension rise 62: Thickness selection 1 63: Thickness selection 2 64–89: Reserved 90: Water cooling system fault 91: Low liquid level fault 92: Revolution count reset 93: DI running enabled	1	-	★
F4-01	DI2 function selection	0–93	4	-	★
F4-02	DI3 function selection	0–93	9	-	★
F4-03	DI4 function selection	0–93	12	-	★
F4-04	DI5 function selection	0–93	13	-	★
F4-05	DI6 function selection	0–93	0	-	★

Parameters

Para. No.	Name	Value Range	Default	Unit	Property
F4-06	DI7 function selection	0–93	0	-	★
F4-07	DI8 function selection	0–93	0	-	★
F4-08	DI9 function selection	0–93	0	-	★
F4-09	DI10 function selection	0–93	0	-	★
F4-10	DI filter time	0.000–1.000s	0.010s	s	☆
F4-11	Terminal control mode	0: Two-wire mode 1 1: Two-wire mode 2 2: Three-wire mode 1 3: Three-wire mode 2	0	-	★
F4-12	Terminal UP/DOWN change rate	0.001–65.535 Hz/s	1.000 Hz/s	Hz/s	☆
F4-13	AI curve 1 minimum input	–1000 to value of F4-15	–10.00 V	V	☆
F4-14	Percentage corresponding to AI curve 1 minimum input	–100.0% to +100.0%	–100.0%	%	☆
F4-15	AI curve 1 maximum input	Value of F4-13 to 1000	10.00 V	V	☆
F4-16	Percentage corresponding to AI curve 1 maximum input	–100.0% to +100.0%	100.0%	%	☆
F4-17	AI1 filter time	0.00–10.00s	0.10s	s	☆
F4-18	AI curve 2 minimum input	–10.00 V to value of F4-20	–10.00 V	V	☆
F4-19	Percentage corresponding to AI curve 2 minimum input	–100.0% to +100.0%	–100.0%	%	☆
F4-20	AI curve 2 maximum input	Value of F4-18 to 10.00 V	10.00 V	V	☆
F4-21	Percentage corresponding to AI curve 2 maximum input	–100.0% to +100.0%	100.0%	%	☆
F4-22	AI2 filter time	0.00–10.00s	0.10s	s	☆
F4-23	AI curve 3 minimum input	–10.00 V to value of F4-25	–10.00 V	V	☆
F4-24	Percentage corresponding to AI curve 3 minimum input	–100.0% to +100.0%	–100.0%	%	☆
F4-25	AI curve 3 maximum input	Value of F4-23 to 10.00 V	10.00 V	V	☆
F4-26	Percentage corresponding to AI curve 3 maximum input	–100.0% to +100.0%	100.0%	%	☆
F4-27	AI3 filter time	0.00–10.00s	0.10s	s	☆
F4-28	Pulse minimum input	0 to value of F4-30	0.00 kHz	kHz	☆

Para. No.	Name	Value Range	Default	Unit	Property
F4-29	Percentage corresponding to pulse minimum input	-100.0% to +100.0%	0.0%	%	☆
F4-30	Pulse maximum input	Value of F4-28 to 10000	100 Hz	kHz	☆
F4-31	Percentage corresponding to pulse maximum input	-100.0% to +100.0%	100.0%	%	☆
F4-32	Pulse filter time	0.00-10.00s	0.10s	s	☆
F4-33	AI curve selection	Ones (position): 1: Curve 1 (two points) 2: Curve 2 (two points) 3: Reserved 4: Curve 4 (four points) 5: Curve 5 (four points) Tens (position): 1: Curve 1 (two points) 2: Curve 2 (two points) 3: Reserved 4: Curve 4 (four points) 5: Curve 5 (four points) Hundreds (position): 1: Curve 1 (two points) 2: Curve 2 (two points) 3: Reserved 4: Curve 4 (four points) 5: Curve 5 (four points)	321	-	☆
F4-34	Setting for the AI lower than the minimum input	Ones (position): 0: Percentage corresponding to minimum input 1: 0.0% Tens (position): 0: Percentage corresponding to minimum input 1: 0.0% Hundreds (position): 0: Percentage corresponding to minimum input 1: 0.0%	0	-	☆
F4-35	DI1 delay	0.0-3600.0s	0.0s	s	☆
F4-36	DI2 delay	0.0-3600.0s	0.0s	s	☆
F4-37	DI3 delay	0.0-3600.0s	0.0s	s	☆

Para. No.	Name	Value Range	Default	Unit	Property
F4-38	DI valid mode setting 1	Ones (position): DI1 active mode 0: Active high 1: Active low Tens (position): DI2 active mode The options are the same as those of DI1. Hundreds (position): DI3 active mode The options are the same as those of DI1. Thousands (position): DI4 active mode The options are the same as those of DI1. Ten thousands (position): DI5 active mode The options are the same as those of DI1.	0	-	★
F4-39	DI valid mode setting 2	Ones (position): DI1 active mode 0: Active high 1: Active low Tens (position): DI2 active mode The options are the same as those of DI1. Hundreds (position): DI3 active mode The options are the same as those of DI1. Thousands (position): DI4 active mode The options are the same as those of DI1. Ten thousands (position): DI5 active mode The options are the same as those of DI1.	0	-	★
F4-42	AI input range selection	0: -10 V to +10 V 1: 0-10 V	0	-	★
Group F5: Output Terminal Parameters					

Para. No.	Name	Value Range	Default	Unit	Property
F5-01	Extension card relay output function selection	0: No output 1: AC drive running 2: Fault output (stop at fault) 3: Frequency level detection FDT1 output 4: Frequency reach 5: Zero-speed running (no output at stop) 6: Motor overload pre-warning 7: AC drive overload pre-warning 8: Set count value reach 9: Designated count value reach 10: Length reach 11: PLC cycle completed 12: Accumulative running time reach 13: Frequency limited 14: Torque limited 15: Ready to run 16: AI1 > AI2 17: Frequency upper limit reach 18: Frequency lower limit reach (operation related) 19: Undervoltage output 20: Communication 21: Reserved 22: Reserved 23: Zero-speed running 2 (at stop) 24: Accumulative power-on time reach 25: Frequency level detection FDT2 output 26: Frequency 1 reach 27: Frequency 2 reach 28: Current 1 reach 29: Current 2 reach 30: Timing reach 31: AI1 input limit exceeded 32: Output load loss	0	-	☆

Parameters

Para. No.	Name	Value Range	Default	Unit	Property
(continued)	(continued)	33: Reverse run 34: Zero current state 35: IGBT temperature reach 36: Output current limit exceeded 37: Frequency lower limit reach (having output at stop) 38: Alarm output (direct output at fault or alarm) 39: Current over-temperature pre-warning 40: Current running time reach 41: Fault output 2 42: Fault output 3 43: Position lock succeeded 46: Brake release output	0	-	☆
F5-02	Control board relay function selection (T/A1-T/B1-TC1)	0-46	2	-	☆
F5-03	Control board relay function selection (T/A2-TC2)	0-46	0	-	☆
F5-04	DO1 function selection	0-46	0	-	☆
F5-05	Extension card DO2 output selection	0-46	4	-	☆
F5-07	AO1 function selection	0: Running frequency 1: Frequency reference 2: Output current 3: Output torque 4: Output power 5: Output voltage 6: Pulse input (100.0% corresponds to 100.00 kHz) 7: AI1 8: AI2 9: AI3 10: Length 11: Count value 12: Communication 13: Motor speed 14: Output current (100.0% corresponds to 1000.0 A) 15: Output voltage (100.0% corresponds to 1000.0 V) 16: Output torque (directional) 19: Taper output 20: Roll diameter output 21: Tension output	0	-	☆

Para. No.	Name	Value Range	Default	Unit	Property
F5-08	AO2 function selection	0–21	1	-	☆
F5-10	AO1 zero offset coefficient	–100.0% to +100.0%	0.0%	%	☆
F5-11	AO1 gain	–10.00 to +10.00	1.00	-	☆
F5-12	AO2 zero offset coefficient	–100.0% to +100.0%	0.0%	%	☆
F5-13	AO2 gain	–10.00 to +10.00	1.00	-	☆
F5-17	Extension card relay output delay	0.0–3600.0s	0.0s	s	☆
F5-18	Relay 1 output delay	0.0–3600.0s	0.0s	s	☆
F5-19	Relay 2 output delay	0.0–3600.0s	0.0	s	☆
F5-20	DO1 output delay	0.0–3600.0s	0.0s	s	☆
F5-21	Extension card DO2 output delay	0.0–3600.0s	0.0s	s	☆
F5-22	DO active mode selection	Ones (position): Extension card relay 0: Positive logic 1: Negative logic Tens (position): Control board relay 1 0: Positive logic 1: Negative logic Hundreds (position): Control board relay 2 0: Positive logic 1: Negative logic Thousands (position): Control board DO1 0: Positive logic 1: Negative logic Ten thousands (position): Extension card DO2 0: Positive logic 1: Negative logic	0	-	☆
Group F6: Start/Stop Control Parameters					
F6-00	Startup mode	0: Direct start 1: Flying start (asynchronous motor) 2: vector pre-excited start (asynchronous motor)	0	-	☆
F6-01	Speed tracking	0: From stop frequency 1: From 50 Hz 2: From the maximum frequency 3: Reserved	0	-	★
F6-02	Speed of speed tracking	1–100	20	-	☆
F6-03	Startup frequency	0.00–10.00 Hz	0.00 Hz	Hz	☆
F6-04	Startup frequency hold time	0.0–100.0s	0.0s	s	★

Parameters

Para. No.	Name	Value Range	Default	Unit	Property
F6-05	DC braking current at startup/Pre-excitation current	0% to 150%	0%	%	★
F6-06	DC braking time at startup/Pre-excitation time	0.0–100.0s	0.0s	s	★
F6-07	Acceleration/ Deceleration mode	0: Linear acceleration/deceleration 1: S-curve acceleration/deceleration	0	-	★
F6-08	Time proportion of S-curve start segment	0.0% to 70.0%	30.0%	%	★
F6-09	Time proportion of S-curve end segment	0.0% to 70.0%	30.0%	%	★
F6-10	Stop mode	0: Decelerate to stop 1: Coast to stop	0	-	☆
F6-11	Starting frequency of DC braking at stop	0.00 Hz to the maximum frequency (F0-10)	0.00 Hz	Hz	☆
F6-12	Waiting time of DC braking at stop	0.0–100.0s	0.0s	s	☆
F6-13	DC braking current at stop	0% to 150%	0%	%	☆
F6-14	DC braking time at stop	0.0–100.0s	0.0s	s	☆
F6-15	Brake usage	0% to 100%	100%	%	★
F6-16	Closed loop current Kp of speed tracking	0–1000	500	-	☆
F6-17	Closed loop current Ki of speed tracking	0–1000	800	-	☆
F6-18	Current of speed tracking	30–200	100	-	☆
F6-21	Demagnetization time	0.00–10.00s	1.00s	s	☆
F6-22	Start pre-torque setting	0.0% to 200%	0.0%	%	☆
F6-26	Electromagnetic shorting current	0% to 200%	100%	%	☆
F6-27	Electromagnetic shorting start time	0.0–100.0s	0.0s	s	★
F6-28	Electromagnetic shorting stop time	0.0–100.0s	0.0s	s	★
F6-29	Electromagnetic shorting voltage reserve	20.0–100.0 V	200	V	★
F6-30	Trial current for synchronous motor speed tracking	50–500	100	-	★

Para. No.	Name	Value Range	Default	Unit	Property
F6-31	Minimum tracking frequency for synchronous motor speed tracking	0.0–100.0	0.0	-	★
F6-32	Angle compensation for synchronous motor speed tracking	0–360	0	-	★
F6-33	Proportion of synchronous motor speed tracking	0.1–10.0	1.0	-	★
F6-34	Integral synchronous motor speed tracking	0.1–10.0	1.0	-	★
F6-35	Maximum current limit for DC braking	80% to 135%	80%	%	★
F6-36	Speed loop feedforward torque setting	–200.0% to +200.0%	0.0%	%	☆
Group F7: Operating Panel and LED Display Parameters					
F7-01	MF.K key function selection	0: MF.K key disabled 1: Switchover between operating panel control and remote control (terminal I/O control or communication control) 2: Switchover between forward and reverse run 3: Forward jog 4: Reverse jog	0	-	★
F7-02	STOP/RES key function	0: STOP/RES key enabled only in operating panel control mode 1: STOP/RES key enabled in any operating mode	0	-	☆
F7-03	LED display of parameters during operation 1	Bit00: Running frequency (Hz) Bit01: Frequency reference (Hz) Bit02: Bus voltage (V) Bit03: Output voltage (V) Bit04: Output current (A) Bit05: Output power (kW) Bit06: Output torque (%) Bit07: DI state Bit08: DO state Bit09: AI1 voltage (V) Bit10: AI2 voltage (V) Bit11: Reserved Bit12: Count value Bit13: Length value Bit14: Load speed display Bit15: PID reference	0x001F	-	☆

Parameters

Para. No.	Name	Value Range	Default	Unit	Property
F7-04	LED display of parameters during operation 2	Bit00: PID feedback Bit01: PLC stage Bit02: Pulse input reference (kHz) Bit03: Running frequency 2 (Hz) Bit04: Remaining running time Bit05: AI1 voltage before correction Bit06: AI2 voltage before correction Bit07: Reserved Bit08: Linear speed Bit09: Current power-on time (Hour) Bit10: Current running time (Min) Bit11: Pulse input reference (Hz) Bit12: Communication Bit13: Encoder feedback speed Bit14: Display of main frequency X Bit15: Display of auxiliary frequency Y	0x0000	-	☆
F7-05	LED display of parameters at stop	Bit00: Frequency reference (Hz) Bit01: Bus voltage (V) Bit02: DI state Bit03: DO state Bit04: AI1 voltage (V) Bit05: AI2 voltage (V) Bit06: Reserved Bit07: Count value Bit08: Length value Bit09: PLC stage Bit10: Load speed display Bit11: PID reference Bit12: Pulse input reference (kHz)	0x0033	-	☆
F7-06	Load speed display coefficient	0.0001–6.5000	1.0000	-	☆
F7-07	Heatsink temperature of IGBT	0.0°C to 99.9°C	-	°C	●
F7-08	Product SN	510	-	-	●
F7-09	Accumulative running time	0–65535 h	-	h	●
F7-10	Performance software version	0.00	0.01	-	●
F7-11	Function software version	0	-	-	●

Para. No.	Name	Value Range	Default	Unit	Property
F7-12	Number of decimal places for load speed display	Ones (position): Number of decimal places for the value of U0-14 0: 0 1: 1 2: 2 3: 3 Tens (position): Number of decimal places for the value of U0-19/U0-29 1: 1 2: 2	11	-	☆
F7-13	Accumulative power-on time	0–65535 h	-	h	●
F7-14	Accumulative power consumption	0° to 65535°	-	°	●
F7-15	Temporary performance software version	0	-	-	●
F7-16	Temporary function software version	0	-	-	●
Group F8: Auxiliary Parameters					
F8-00	Jog frequency	0 to the maximum frequency (F0-10)	2.00 Hz	Hz	☆
F8-01	Jog acceleration time	0.0–6500.0s	20.0s	s	☆
F8-02	Jog deceleration time	0.0–6500.0s	20.0s	s	☆
F8-03	Acceleration time 2	0.0–6500.0s	200	s	☆
F8-04	Deceleration time 2	0.0–6500.0s	200	s	☆
F8-05	Acceleration time 3	0.0–6500.0s	200	s	☆
F8-06	Deceleration time 3	0.0–6500.0s	200	s	☆
F8-07	Acceleration time 4	0.0–6500.0s	200	s	☆
F8-08	Deceleration time 4	0.0–6500.0s	200	s	☆
F8-09	Jump frequency 1	0.00 to the maximum frequency (F0-10)	0.00 Hz	Hz	☆
F8-10	Jump frequency 2	0.00 to the maximum frequency (F0-10)	0.00 Hz	Hz	☆
F8-11	Jump frequency amplitude	0.00–5.00 Hz	0.00 Hz	Hz	☆
F8-12	Forward/Reverse run switchover dead zone time	0.0–3000.0s	0.0s	s	☆
F8-13	Reverse run enable	0: Reverse running allowed 1: Reverse running inhibited	0	-	☆
F8-14	Running mode when frequency reference lower than frequency lower limit	0: Frequency lower limit 1: Stop 2: Zero speed running 3: Coast to stop	0	-	☆
F8-15	Mechanical braking frequency	0.00–10.00 Hz	0.00 Hz	Hz	☆

Parameters

Para. No.	Name	Value Range	Default	Unit	Property
F8-16	Accumulative power-on time threshold	0–65000 h	0 h	h	☆
F8-17	Accumulative running time threshold	0–65000 h	0 h	h	☆
F8-18	Startup protection selection	0: Disabled 1: Enabled	0	-	☆
F8-19	Frequency detection value (FDT1)	0 to the maximum frequency (F0-10)	50.00 Hz	Hz	☆
F8-20	Frequency detection hysteresis (FDT1)	0.0% to 100.0%	5.0%	%	☆
F8-21	Detection width for frequency reach	0.0% to 100.0%	0.0%	%	☆
F8-22	Jump frequency selection during acceleration/ deceleration	0: Disabled 1: Enabled	0	-	☆
F8-23	Action selection upon accumulative running time reach	0–1	0	-	●
F8-24	Action selection upon accumulative power-on time reach	0–1	0	-	●
F8-25	Switchover frequency of acceleration time 1 and acceleration time 2	0 to the maximum frequency (F0-10)	0.00 Hz	Hz	☆
F8-26	Switchover frequency of deceleration time 1 and deceleration time 2	0 to the maximum frequency (F0-10)	0.00 Hz	Hz	☆
F8-27	Jog preferred	0: Disabled 1: Enabled	0	-	☆
F8-28	Frequency detection value (FDT2)	0 to the maximum frequency (F0-10)	50.00 Hz	Hz	☆
F8-29	Frequency detection hysteresis (FDT2)	0.0% to 100.0%	5.0%	%	☆
F8-30	Detection value for frequency reach 1	0 to the maximum frequency (F0-10)	50.00 Hz	Hz	☆
F8-31	Detection width for frequency reach 1	0.0% to 100.0%	0.0%	%	☆
F8-32	Detection value for frequency reach 2	0 to the maximum frequency (F0-10)	50.00 Hz	Hz	☆
F8-33	Detection width for frequency reach 2	0.0% to 100.0%	0.0%	%	☆
F8-34	Zero current detection level	0.0% to 300.0%	5.0%	%	☆
F8-35	Zero current detection delay	0.01–600.00s	0.10s	s	☆

Para. No.	Name	Value Range	Default	Unit	Property
F8-36	Output overcurrent threshold	0.0% to 300.0%	200.0%	%	☆
F8-37	Output overcurrent detection delay	0.00–600.00s	0.00s	s	☆
F8-38	Detection level of current 1	0.0% to 300.0%	100.0%	%	☆
F8-39	Detection width of current 1	0.0% to 300.0%	0.0%	%	☆
F8-40	Detection level of current 2	0.0% to 300.0%	100.0%	%	☆
F8-41	Detection width of current 2	0.0% to 300.0%	0.0%	%	☆
F8-42	Timing function	0: Disabled 1: Enabled	0	-	★
F8-43	Timing duration source	0: Timing duration (specified by F8-44) 1: AI1 2: AI2	0	-	★
F8-44	Timing duration	0.0–6500.0 min	0.0 min	min	★
F8-45	AI1 input voltage lower limit	0.00 V to value of F8-46	3.10 V	V	☆
F8-46	AI1 input voltage upper limit	Value of F8-45 to 11.00 V	6.80 V	V	☆
F8-47	IGBT temperature reach	0°C to 100°C	75°C	°C	☆
F8-48	Cooling fan working mode	0: Working during drive running 1: Working continuously	0	-	☆
F8-49	Wakeup frequency	Value of F8-51 to the maximum frequency (F0-10)	0.00 Hz	Hz	☆
F8-50	Wakeup delay	0.0–6500.0s	0.0s	s	☆
F8-51	Sleep frequency	0 to value of F8-49	0.00 Hz	Hz	☆
F8-52	Sleep delay	0.0–6500.0s	0.0s	s	☆
F8-53	Current running time threshold	0.0–6500.0 min	0.0 min	min	☆
F8-54	STO selection	0: Disabled 1: Enabled	0	-	★
F8-55	Deceleration time for emergency stop	0.0–6500.0s	0.0s	s	☆
F8-56	LED operating panel jog	0	0	-	●
Group F9: Fault and Protection Parameters					
F9-00	AC drive overload protection	0: Disabled 1: Enabled	0	-	☆
F9-01	Motor overload protection gain	0.20–10.00	1.00	-	☆
F9-02	Motor overload pre-warning coefficient	50% to 100%	80%	%	☆

Parameters

Para. No.	Name	Value Range	Default	Unit	Property
F9-04	Overvoltage threshold	350.0–820.0 V	820.0 V	V	☆
F9-05	Voltage dip suppression time	0.0–600.0s	0.5s	s	☆
F9-06	Output phase loss detection before startup	0: Disabled 1: Enabled	0	-	☆
F9-07	Detection of short-circuit to ground	0: No detection 1: Detection before power-on 2: Detection before running 3: Detection before power-on and running	1	-	★
F9-08	Braking unit applied voltage	200.0–2000.0 V	760.0 V	V	☆
F9-09	Fault auto reset times	0–20	0	-	☆
F9-10	DO action during auto fault reset	0: Not act 1: Act	0	-	☆
F9-11	Automatic fault reset interval	0.1–100.0s	1.0s	s	☆
F9-12	Input phase loss/ Contactor pickup protection	Ones (position): Input phase loss protection selection 0: Input phase loss detection inhibited 1: Input phase loss detected by software and hardware 2: Input phase loss detected by software 3: Input phase loss detected by hardware Tens (position): Contactor close/Fan fault protection 0: Inhibited 1: Enabled	11	-	☆
F9-13	Restart interval upon fault reset	0.0–600.0s	10.0s	s	☆
F9-14	1st fault type	0–99	-	-	●
F9-15	2nd fault type	0–99	-	-	●
F9-16	3rd (latest) fault type	0–99	-	-	●
F9-17	Frequency upon 3rd (latest) fault	0.00–655.35 Hz	-	Hz	●
F9-18	Current upon 3rd (latest) fault	0.0–6553.5 A	-	A	●
F9-19	Bus voltage upon 3rd (latest) fault	0.0–6553.5 V	-	V	●
F9-20	Input terminal state upon 3rd (latest) fault	0–9999	-	-	●
F9-21	Output terminal state upon 3rd (latest) fault	0–9999	-	-	●

Para. No.	Name	Value Range	Default	Unit	Property
F9-22	AC drive state upon 3rd (latest) fault	0-65535	-	-	●
F9-23	Power-on time upon 3rd (latest) fault	0-65535	-	-	●
F9-24	Running time upon 3rd (latest) fault	0.0-6553.5	-	-	●
F9-25	IGBT temperature upon 3rd (latest) fault	0-999	-	-	●
F9-26	Fault subcode upon 3rd (latest) fault	0-65535	-	-	●
F9-27	Frequency upon 2nd fault	0.00-655.35 Hz	-	Hz	●
F9-28	Current upon 2nd fault	0.0-6553.5 A	-	A	●
F9-29	Bus voltage upon 2nd fault	0.0-6553.5 V	-	V	●
F9-30	Input terminal state upon 2nd fault	0-9999	-	-	●
F9-31	Output terminal state upon 2nd fault	0-9999	-	-	●
F9-32	AC drive state upon 2nd fault	0-65535	-	-	●
F9-33	Power-on time upon 2nd fault	0-65535	-	-	●
F9-34	Running time upon 2nd fault	0.0-6553.5	-	-	●
F9-35	IGBT temperature upon 2nd fault	0-999	-	-	●
F9-36	Fault subcode upon 2nd fault	0-65535	-	-	●
F9-37	Frequency upon 1st fault	0.00-655.35 Hz	-	Hz	●
F9-38	Current upon 1st fault	0.0-6553.5 A	-	A	●
F9-39	Bus voltage upon 1st fault	0.0-6553.5 V	-	V	●
F9-40	Input terminal state upon 1st fault	0-9999	-	-	●
F9-41	Output terminal state upon 1st fault	0-9999	-	-	●
F9-42	AC drive state upon 1st fault	0-65535	-	-	●
F9-43	Power-on time upon 1st fault	0-65535	-	-	●
F9-44	Running time upon 1st fault	0.0-6553.5	-	-	●

Parameters

Para. No.	Name	Value Range	Default	Unit	Property
F9-45	IGBT temperature upon 1st fault	0–999	-	-	●
F9-46	Fault subcode upon 1st fault	0–65535	-	-	●
F9-47	Fault protection action selection 0	Ones (position): Value of E02/E03/E04 0: Coast to stop 2: Fault reset Tens (position): Value of E05/E06/E07 0: Coast to stop 2: Fault reset Hundreds (position): Value of E08 0: Coast to stop Thousands (position): Value E09 0: Coast to stop 2: Fault reset Ten thousands (position): Value of E10 0: Coast to stop 2: Fault reset	0	-	★
F9-48	Fault protection action selection 1	Ones (position): Value of E11 0: Coast to stop 1: Decelerate to stop 2: Fault reset 4: Warning 5: Canceled Tens (position): Value of E12 0: Coast to stop 1: Decelerate to stop 2: Fault reset 4: Warning 5: Canceled Hundreds (position): Value of E13 0: Coast to stop 1: Decelerate to stop 2: Fault reset 4: Warning 5: Canceled Thousands (position): Value of E14 0: Coast to stop Ten thousands (position): Value of E15 0: Coast to stop 1: Decelerate to stop 3: Electromagnetic shorting 4: Warning 5: Canceled	0	-	★

Para. No.	Name	Value Range	Default	Unit	Property
F9-49	Fault protection action selection 2	<p>Ones (position): Value of E16 0: Coast to stop 1: Decelerate to stop 4: Warning 5: Canceled</p> <p>Tens (position): Value of E17 0: Coast to stop 1: Decelerate to stop 4: Warning 5: Canceled</p> <p>Hundreds (position): Value of E18 0: Coast to stop</p> <p>Thousands (position): Value of E19 0: Coast to stop 3: Electromagnetic shorting 4: Warning 5: Canceled</p> <p>Ten thousands (position): Value of E20 0: Coast to stop 3: Electromagnetic shorting 4: Warning 5: Canceled</p>	0	-	★
F9-50	Fault protection action selection 3	<p>Ones (position): Reserved 0: Coast to stop</p> <p>Tens (position): Value of E63 0: Coast to stop 1: Decelerate to stop 4: Warning 5: Canceled</p> <p>Hundreds (position): Value of E23 0: Coast to stop 5: Canceled</p> <p>Thousands (position): Value of E24 0: Coast to stop 5: Canceled</p> <p>Ten thousands (position): Value of E25 0: Coast to stop 1: Decelerate to stop 4: Warning 5: Canceled</p>	5040	-	★

Parameters

Para. No.	Name	Value Range	Default	Unit	Property
F9-51	Fault protection action selection 4	<p>Ones (position): Value of E26 0: Coast to stop 1: Decelerate to stop 4: Warning 5: Canceled</p> <p>Tens position: Value of E27 0: Coast to stop 1: Decelerate to stop 3: Electromagnetic shorting 4: Warning 5: Canceled</p> <p>Hundreds (position): Value of E28 0: Coast to stop 1: Decelerate to stop 3: Electromagnetic shorting 4: Warning 5: Canceled</p> <p>Thousands (position): Value of E29 0: Coast to stop 1: Decelerate to stop 4: Warning 5: Canceled</p> <p>Ten thousands (position): Value of E30 0: Coast to stop 1: Decelerate to stop 4: Warning 5: Canceled</p>	51111	-	★

Para. No.	Name	Value Range	Default	Unit	Property
F9-52	Fault protection action selection 5	<p>Ones (position): Value of E31 0: Coast to stop 1: Decelerate to stop 4: Warning 5: Canceled</p> <p>Tens (position): Value of E40 0: Coast to stop 2: Fault reset</p> <p>Hundreds (position): Value of E41 0: Coast to stop 1: Decelerate to stop 4: Warning 5: Canceled</p> <p>Thousands (position): Value of E42 0: Coast to stop 1: Decelerate to stop 2: Fault reset 3: Electromagnetic shorting 4: Warning 5: Canceled</p> <p>Ten thousands (position): Value of E43 0: Coast to stop 1: Decelerate to stop 3: Electromagnetic shorting 4: Warning 5: Canceled</p>	101	-	★
F9-53	Fault protection action selection 6	<p>Ones (position): Value of E45 0: Coast to stop 1: Decelerate to stop 4: Warning 5: Canceled</p> <p>Tens (position): Value of E60 0: Coast to stop 1: Decelerate to stop 4: Warning 5: Canceled</p> <p>Hundreds (position): Value of E61 0: Coast to stop 1: Decelerate to stop 4: Warning 5: Canceled</p> <p>Thousands (position): Value of E62 0: Coast to stop 5: Canceled</p> <p>Ten thousands (position): Reserved 5: Canceled</p>	0	-	★

Parameters

Para. No.	Name	Value Range	Default	Unit	Property
F9-54	Frequency selection for continuing to run upon fault	0: Current running frequency 1: Frequency reference 2: Frequency upper limit 3: Frequency lower limit 4: Backup frequency upon abnormality	1	-	☆
F9-55	Backup frequency reference	0.0% to 100.0%	100.0%	%	☆
F9-57	Motor overtemperature protection threshold	0°C to 200°C	110°C	°C	☆
F9-58	Motor overtemperature pre-warning threshold	0°C to 200°C	90°C	°C	☆
F9-59	Power dip ride-through function selection	0: Disabled 1: Decelerate 2: Decelerate to stop 3: Voltage dip depression	0	-	★
F9-60	Threshold for recovering from power dip ride-through	80% to 100%	85%	%	☆
F9-61	Duration for judging voltage recovery from power dip ride-through	0.0–100.0s	0.5s	s	☆
F9-62	Threshold for enabling power dip ride-through	60% to 100%	80%	%	☆
F9-63	Runaway protection time in FVC mode	0–10000	0	-	★
F9-64	Load loss detection level	0.0% to 100.0%	10.0%	%	☆
F9-65	Load loss detection time	0.0s–60.0s	1.0s	s	☆
F9-67	Overspeed threshold	0.0% to 50.0%	5.0%	%	☆
F9-68	Overspeed detection time	0.0–60.0	1.0	-	☆
F9-69	Excessive speed deviation threshold	0.0% to 50.0%	20.0%	%	☆
F9-70	Detection time of excessive speed deviation	0.0s–60.0s	5.0s	s	☆
F9-71	Power dip ride-through gain	0–100	40	-	☆
F9-72	Power dip ride-through integral coefficient	0–100	30	-	☆
F9-73	Deceleration time of power dip ride-through	0.0–300.0s	20.0s	s	☆
Group FA: Process Control PID Parameters					

Para. No.	Name	Value Range	Default	Unit	Property
FA-00	PID reference source	0: Digital setting of PID (FA-01) 1: AI1 2: AI2 3: AI3 4: Pulse reference (DI5) 5: Communication 6: Multi-reference	0	-	☆
FA-01	Digital setting of PID	0.0% to 100.0%	50.0%	%	☆
FA-02	PID feedback source	0: AI1 1: AI2 2: AI3 3: AI1 – AI2 4: Pulse reference (DIO1) 5: Communication 6: AI1 + AI2 7: Max. (AI1 , AI2) 8: Min. (AI1 , AI2) 9: Reserved	0	-	☆
FA-03	PID action direction	0: Forward 1: Reverse	0	-	☆
FA-04	PID reference and feedback range	0–65535	1000	-	☆
FA-05	Proportional gain Kp1	0.0–1000.0	20.0	-	☆
FA-06	Integral time Ti1	0.01–100.00s	2.00s	s	☆
FA-07	Derivative time Td1	0.000–10.000s	0.000s	s	☆
FA-08	PID output limit in reverse direction	0 to the maximum frequency (F0-10)	2.00 Hz	Hz	☆
FA-09	PID deviation limit	0.0% to 100.0%	0.0%	%	☆
FA-10	PID differential limit	0.00% to 100.00%	0.10%	%	☆
FA-11	PID reference change time	0.00–650.00s	0.00s	s	☆
FA-12	PID feedback filter time	0.00–60.00s	0.00s	s	☆
FA-13	PID deviation gain	0.0% to 100.0%	1	%	☆
FA-14	PID optimization	0–100	0	-	☆
FA-15	Proportional gain Kp2	0.0–1000.0	20.0	-	☆
FA-16	Integral time Ti2	0.01–100.00s	2.00s	s	☆
FA-17	Derivative time Td2	0.000–10.000s	0.000s	s	☆

Parameters

Para. No.	Name	Value Range	Default	Unit	Property
FA-18	PID parameter switchover condition	0: No switchover 1: Switchover by DI 2: Automatic switchover based on deviation 3: Switchover based on running frequency 6: Automatic adjustment based on roll diameter 7: Automatic adjustment based on maximum roll diameter percentage	0	-	☆
FA-19	PID parameter switchover deviation 1	0 to value of FA-20	20.0%	%	☆
FA-20	PID parameter switchover deviation 2	Value of FA-19 to 1000	80.0%	%	☆
FA-21	PID initial value	0.0% to 100.0%	0.0%	%	☆
FA-22	Hold time of PID initial value	0.00–650.00s	0.00s	s	☆
FA-23	Maximum deviation between two PID outputs in forward direction	0.00% to 100.00%	1.00%	%	☆
FA-24	Maximum deviation between two PID outputs in reverse direction	0.00% to 100.00%	1.00%	%	☆
FA-25	PID integral property	0: Disabled 1: Enabled	0		☆
FA-26	Detection level of PID feedback loss	0.0% to 100.0%	0.0%	%	☆
FA-27	Detection time of PID feedback loss	0.0–20.0s	0.0s	s	☆
Group Fb: Wobble, Fixed Length and Count Parameters					
Fb-00	Wobble setting mode	0: Relative to central frequency 1: Relative to maximum frequency	0	-	☆
Fb-01	Wobble amplitude	0.0% to 100.0%	0.0%	%	☆
Fb-02	Jump frequency amplitude	0.0% to 50.0%	0.0%	%	☆
Fb-03	Wobble cycle	0.1–3000.0s	10.0s	s	☆
Fb-04	Triangular wave rise time coefficient	0.1% to 100.0%	50.0%	%	☆
Fb-05	Set length	0–65535 m	1000 m	m	☆
Fb-06	Actual length	0–65535 m	0 m	m	☆
Fb-07	Number of pulses per meter	0.1–6553.5	100.0	-	☆
Fb-08	Set count value	1–65535	1000	-	☆
Fb-09	Designated count value	1–65535	1000	-	☆

Para. No.	Name	Value Range	Default	Unit	Property
Fb-10	Revolution count reset mode	0: Edge trigger 1: Level trigger	0	-	☆
Fb-11	Revolution count reset signal	0: Disable 1: Enable	0	-	☆
Fb-12	Revolution count retentive at power failure	0: No 1: Yes	0	-	☆
Fb-13	Revolution count clear	0–65535	0	-	☆
Fb-14	Transmission ratio numerator	1–65535	1	-	☆
Fb-15	Transmission ratio denominator	1–65535	1	-	☆
Fb-16	Actual running revolutions	0–65535	0	-	●
Fb-17	Running revolutions	0–65535	0	-	●
Fb-18	Running revolution accuracy	0: 1 revolution 1: 0.1 revolution	0	-	☆
Fb-19	Revolution recording direction	0: Forward 1: Reverse	0	-	☆
Group FC: Multi-reference and Simple PLC Parameters					
FC-00	Multi-reference 0	–100.0% to +100.0%	0.0%	%	☆
FC-01	Multi-reference 1	–100.0% to +100.0%	0.0%	%	☆
FC-02	Multi-reference 2	–100.0% to +100.0%	0.0%	%	☆
FC-03	Multi-reference 3	–100.0% to +100.0%	0.0%	%	☆
FC-04	Multi-reference 4	–100.0% to +100.0%	0.0%	%	☆
FC-05	Multi-reference 5	–100.0% to +100.0%	0.0%	%	☆
FC-06	Multi-reference 6	–100.0% to +100.0%	0.0%	%	☆
FC-07	Multi-reference 7	–100.0% to +100.0%	0.0%	%	☆
FC-08	Multi-reference 8	–100.0% to +100.0%	0.0%	%	☆
FC-09	Multi-reference 9	–100.0% to +100.0%	0.0%	%	☆
FC-10	Multi-reference 10	–100.0% to +100.0%	0.0%	%	☆
FC-11	Multi-reference 11	–100.0% to +100.0%	0.0%	%	☆
FC-12	Multi-reference 12	–100.0% to +100.0%	0.0%	%	☆
FC-13	Multi-reference 13	–100.0% to +100.0%	0.0%	%	☆
FC-14	Multi-reference 14	–100.0% to +100.0%	0.0%	%	☆
FC-15	Multi-reference 15	–100.0% to +100.0%	0.0%	%	☆
FC-16	Simple PLC running mode	0: Stop after running for one cycle 1: Keep final values after running for one cycle 2: Repeat after running for one cycle	0	-	☆

Parameters

Para. No.	Name	Value Range	Default	Unit	Property
FC-17	Retentive memory selection of simple PLC	Ones (position): Retentive upon power failure 0: No 1: Yes Tens (position): Retentive upon stop 0: No 1: Yes	0	-	☆
FC-18	Running time of PLC reference 0	0.0–6553.5s (h)	0.0s (h)	s (h)	☆
FC-19	Acceleration/Deceleration time of PLC reference 0	0: Group 1 acceleration/deceleration time (F0-17 and F7-18) 1: Group 2 acceleration/deceleration time (F8-03 and F8-04) 2: Group 3 acceleration/deceleration time (F8-05 and F8-06) 3: Group 4 acceleration/deceleration time (F8-07 and F8-08)	0	-	☆
FC-20	Running time of PLC reference 1	0.0–6553.5s (h)	0.0s (h)	s (h)	☆
FC-21	Acceleration/Deceleration time of PLC reference 1	0: Group 1 acceleration/deceleration time (F0-17 and F7-18) 1: Group 2 acceleration/deceleration time (F8-03 and F8-04) 2: Group 3 acceleration/deceleration time (F8-05 and F8-06) 3: Group 4 acceleration/deceleration time (F8-07 and F8-08)	0	-	☆
FC-22	Running time of PLC reference 2	0.0–6553.5s (h)	0.0s (h)	s (h)	☆
FC-23	Acceleration/Deceleration time of PLC reference 2	0: Group 1 acceleration/deceleration time (F0-17 and F7-18) 1: Group 2 acceleration/deceleration time (F8-03 and F8-04) 2: Group 3 acceleration/deceleration time (F8-05 and F8-06) 3: Group 4 acceleration/deceleration time (F8-07 and F8-08)	0	-	☆
FC-24	Running time of PLC reference 3	0.0–6553.5s (h)	0.0s (h)	s (h)	☆
FC-25	Acceleration/Deceleration time of PLC reference 3	0: Group 1 acceleration/deceleration time (F0-17 and F7-18) 1: Group 2 acceleration/deceleration time (F8-03 and F8-04) 2: Group 3 acceleration/deceleration time (F8-05 and F8-06) 3: Group 4 acceleration/deceleration time (F8-07 and F8-08)	0	-	☆

Para. No.	Name	Value Range	Default	Unit	Property
FC-26	Running time of PLC reference 4	0.0–6553.5s (h)	0.0s (h)	s (h)	☆
FC-27	Acceleration/ Deceleration time of PLC reference 4	0: Group 1 acceleration/deceleration time (F0-17 and F7-18) 1: Group 2 acceleration/deceleration time (F8-03 and F8-04) 2: Group 3 acceleration/deceleration time (F8-05 and F8-06) 3: Group 4 acceleration/deceleration time (F8-07 and F8-08)	0	-	☆
FC-28	Running time of PLC reference 5	0.0–6553.5s (h)	0.0s (h)	s (h)	☆
FC-29	Acceleration/ Deceleration time of PLC reference 5	0: Group 1 acceleration/deceleration time (F0-17 and F7-18) 1: Group 2 acceleration/deceleration time (F8-03 and F8-04) 2: Group 3 acceleration/deceleration time (F8-05 and F8-06) 3: Group 4 acceleration/deceleration time (F8-07 and F8-08)	0	-	☆
FC-30	Running time of PLC reference 6	0.0–6553.5s (h)	0.0s (h)	s (h)	☆
FC-31	Acceleration/ Deceleration time of PLC reference 6	0: Group 1 acceleration/deceleration time (F0-17 and F7-18) 1: Group 2 acceleration/deceleration time (F8-03 and F8-04) 2: Group 3 acceleration/deceleration time (F8-05 and F8-06) 3: Group 4 acceleration/deceleration time (F8-07 and F8-08)	0	-	☆
FC-32	Running time of PLC reference 7	0.0–6553.5s (h)	0.0s (h)	s (h)	☆
FC-33	Acceleration/ Deceleration time of PLC reference 7	0: Group 1 acceleration/deceleration time (F0-17 and F7-18) 1: Group 2 acceleration/deceleration time (F8-03 and F8-04) 2: Group 3 acceleration/deceleration time (F8-05 and F8-06) 3: Group 4 acceleration/deceleration time (F8-07 and F8-08)	0	-	☆
FC-34	Running time of PLC reference 8	0.0–6553.5s (h)	0.0s (h)	s (h)	☆

Parameters

Para. No.	Name	Value Range	Default	Unit	Property
FC-35	Acceleration/ Deceleration time of PLC reference 8	0: Group 1 acceleration/deceleration time (F0-17 and F7-18) 1: Group 2 acceleration/deceleration time (F8-03 and F8-04) 2: Group 3 acceleration/deceleration time (F8-05 and F8-06) 3: Group 4 acceleration/deceleration time (F8-07 and F8-08)	0	-	☆
FC-36	Running time of PLC reference 9	0.0–6553.5s (h)	0.0s (h)	s (h)	☆
FC-37	Acceleration/ Deceleration time of PLC reference 9	0: Group 1 acceleration/deceleration time (F0-17 and F7-18) 1: Group 2 acceleration/deceleration time (F8-03 and F8-04) 2: Group 3 acceleration/deceleration time (F8-05 and F8-06) 3: Group 4 acceleration/deceleration time (F8-07 and F8-08)	0	-	☆
FC-38	Running time of PLC reference 10	0.0–6553.5s (h)	0.0s (h)	s (h)	☆
FC-39	Acceleration/ Deceleration time of PLC reference 10	0: Group 1 acceleration/deceleration time (F0-17 and F7-18) 1: Group 2 acceleration/deceleration time (F8-03 and F8-04) 2: Group 3 acceleration/deceleration time (F8-05 and F8-06) 3: Group 4 acceleration/deceleration time (F8-07 and F8-08)	0	-	☆
FC-40	Running time of PLC reference 11	0.0–6553.5s (h)	0.0s (h)	s (h)	☆
FC-41	Acceleration/ Deceleration time of PLC reference 11	0: Group 1 acceleration/deceleration time (F0-17 and F7-18) 1: Group 2 acceleration/deceleration time (F8-03 and F8-04) 2: Group 3 acceleration/deceleration time (F8-05 and F8-06) 3: Group 4 acceleration/deceleration time (F8-07 and F8-08)	0	-	☆
FC-42	Running time of PLC reference 12	0.0–6553.5s (h)	0.0s (h)	s (h)	☆

Para. No.	Name	Value Range	Default	Unit	Property
FC-43	Acceleration/ Deceleration time of PLC reference 12	0: Group 1 acceleration/deceleration time (F0-17 and F7-18) 1: Group 2 acceleration/deceleration time (F8-03 and F8-04) 2: Group 3 acceleration/deceleration time (F8-05 and F8-06) 3: Group 4 acceleration/deceleration time (F8-07 and F8-08)	0	-	☆
FC-44	Running time of PLC reference 13	0.0–6553.5s (h)	0.0s (h)	s (h)	☆
FC-45	Acceleration/ Deceleration time of PLC reference 13	0: Group 1 acceleration/deceleration time (F0-17 and F7-18) 1: Group 2 acceleration/deceleration time (F8-03 and F8-04) 2: Group 3 acceleration/deceleration time (F8-05 and F8-06) 3: Group 4 acceleration/deceleration time (F8-07 and F8-08)	0	-	☆
FC-46	Running time of PLC reference 14	0.0–6553.5s (h)	0.0s (h)	s (h)	☆
FC-47	Acceleration/ Deceleration time of PLC reference 14	0: Group 1 acceleration/deceleration time (F0-17 and F7-18) 1: Group 2 acceleration/deceleration time (F8-03 and F8-04) 2: Group 3 acceleration/deceleration time (F8-05 and F8-06) 3: Group 4 acceleration/deceleration time (F8-07 and F8-08)	0	-	☆
FC-48	Running time of PLC reference 15	0.0–6553.5s (h)	0.0s (h)	s (h)	☆
FC-49	Acceleration/ Deceleration time of PLC reference 15	0: Group 1 acceleration/deceleration time (F0-17 and F7-18) 1: Group 2 acceleration/deceleration time (F8-03 and F8-04) 2: Group 3 acceleration/deceleration time (F8-05 and F8-06) 3: Group 4 acceleration/deceleration time (F8-07 and F8-08)	0	-	☆
FC-50	PLC running time unit	0: s (second) 1: h (hour)	0	-	☆

Parameters

Para. No.	Name	Value Range	Default	Unit	Property
FC-51	Multi-reference 0 source	0: Multi-reference 0 (FC-00) 1: AI1 2: AI2 3: AI3 4: Pulse reference (DI5) 5: PID 6: Preset frequency (value of F0-08 that can be changed by pressing UP/DOWN)	0	-	☆
Group Fd: Communication Parameters					
Fd-00	Baud rate	0: 300 bps 1: 600 bps 2: 1200 bps 3: 2400 bps 4: 4800 bps 5: 9600 bps 6: 19200 bps 7: 38400 bps 8: 57600 bps 9: 115200 bps	5	-	☆
Fd-01	Modbus data format	0: No check (8-N-2) 1: Even parity check (8-E-1) 2: Odd parity check (8-O-1) 3: 8-N-1	0	-	☆
Fd-02	Local address	0: Broadcast address 1–247	1	-	☆
Fd-03	Response delay	0–20 ms	2 ms	ms	☆
Fd-04	Modbus timeout time	0.0s (invalid) 0.1–60.0 s	0.0s	s	☆
Fd-06	Communication fault reset	0: Disabled 1: Enabled	1	-	★
Fd-09	CANopen/CANlink communication state	Ones: CANopen 0: Stop 1: Initialized 2: Pre-running 8: Running Tens: CANlink 0: Stop 1: Initialized 2: Pre-running 8: Running	2	-	●
Fd-10	Switchover between CANopen and CANlink	1: CANopen 2: CANlink	1	-	★
Fd-11	CANopen402 selection	0: Disabled 1: Enabled	0	-	★

Para. No.	Name	Value Range	Default	Unit	Property
Fd-12	CAN baud rate	0: 20 kbps 1: 50 kbps 2: 100 kbps 3: 125 kbps 4: 250 kbps 5: 500 kbps 6: 1 Mbps	5	-	★
Fd-13	CAN station number	1–127	1	-	★
Fd-14	Number of CAN frames received per unit of time	0–65535	0	-	●
Fd-15	Maximum value of node reception error counter	0–65535	0	-	●
Fd-16	Maximum value of node transmission error counter	0–65535	0	-	●
Fd-17	Bus disconnection times per unit of time	1–65535	0	-	●
Fd-94	Modbus software version	0–65535	0	-	●
Fd-95	CANlink software version	0–65535	0	-	●
Fd-96	CANopen software version	0–65535	0	-	●
Group FE: User-defined Parameters					
FE-00	User-defined parameter 0	F0-00 to FP-xx A0-00 to Ax-xx U0-xx to U0-xx U3-00 to U3-xx	7017	-	☆
FE-01	User-defined parameter 1	F0-00 to FP-xx A0-00 to Ax-xx U0-xx to U0-xx U3-00 to U3-xx	7016	-	☆
FE-02	User-defined parameter 2	F0-00 to FP-xx A0-00 to Ax-xx U0-xx to U0-xx U3-00 to U3-xx	0	-	☆
FE-03	User-defined parameter 3	F0-00 to FP-xx A0-00 to Ax-xx U0-xx to U0-xx U3-00 to U3-xx	0	-	☆
FE-04	User-defined parameter 4	F0-00 to FP-xx A0-00 to Ax-xx U0-xx to U0-xx U3-00 to U3-xx	0	-	☆

Parameters

Para. No.	Name	Value Range	Default	Unit	Property
FE-05	User-defined parameter 5	F0-00 to FP-xx A0-00 to Ax-xx U0-xx to U0-xx U3-00 to U3-xx	0	-	☆
FE-06	User-defined parameter 6	F0-00 to FP-xx A0-00 to Ax-xx U0-xx to U0-xx U3-00 to U3-xx	0	-	☆
FE-07	User-defined parameter 7	F0-00 to FP-xx A0-00 to Ax-xx U0-xx to U0-xx U3-00 to U3-xx	0	-	☆
FE-08	User-defined parameter 8	F0-00 to FP-xx A0-00 to Ax-xx U0-xx to U0-xx U3-00 to U3-xx	0	-	☆
FE-09	User-defined parameter 9	F0-00 to FP-xx A0-00 to Ax-xx U0-xx to U0-xx U3-00 to U3-xx	0	-	☆
FE-10	User-defined parameter 10	F0-00 to FP-xx A0-00 to Ax-xx U0-xx to U0-xx U3-00 to U3-xx	0	-	☆
FE-11	User-defined parameter 11	F0-00 to FP-xx A0-00 to Ax-xx U0-xx to U0-xx U3-00 to U3-xx	0	-	☆
FE-12	User-defined parameter 12	F0-00 to FP-xx A0-00 to Ax-xx U0-xx to U0-xx U3-00 to U3-xx	0	-	☆
FE-13	User-defined parameter 13	F0-00 to FP-xx A0-00 to Ax-xx U0-xx to U0-xx U3-00 to U3-xx	0	-	☆
FE-14	User-defined parameter 14	F0-00 to FP-xx A0-00 to Ax-xx U0-xx to U0-xx U3-00 to U3-xx	0	-	☆
FE-15	User-defined parameter 15	F0-00 to FP-xx A0-00 to Ax-xx U0-xx to U0-xx U3-00 to U3-xx	0	-	☆
FE-16	User-defined parameter 16	F0-00 to FP-xx A0-00 to Ax-xx U0-xx to U0-xx U3-00 to U3-xx	0	-	☆

Para. No.	Name	Value Range	Default	Unit	Property
FE-17	User-defined parameter 17	F0-00 to FP-xx A0-00 to Ax-xx U0-xx to U0-xx U3-00 to U3-xx	0	-	☆
FE-18	User-defined parameter 18	F0-00 to FP-xx A0-00 to Ax-xx U0-xx to U0-xx U3-00 to U3-xx	0	-	☆
FE-19	User-defined parameter 19	F0-00 to FP-xx A0-00 to Ax-xx U0-xx to U0-xx U3-00 to U3-xx	0	-	☆
FE-20	User-defined parameter 20	F0-00 to FP-xx A0-00 to Ax-xx U0-xx to U0-xx U3-00 to U3-xx	6768	-	☆
FE-21	User-defined parameter 21	F0-00 to FP-xx A0-00 to Ax-xx U0-xx to U0-xx U3-00 to U3-xx	6769	-	☆
FE-22	User-defined parameter 22	F0-00 to FP-xx A0-00 to Ax-xx U0-xx to U0-xx U3-00 to U3-xx	0	-	☆
FE-23	User-defined parameter 23	F0-00 to FP-xx A0-00 to Ax-xx U0-xx to U0-xx U3-00 to U3-xx	0	-	☆
FE-24	User-defined parameter 24	F0-00 to FP-xx A0-00 to Ax-xx U0-xx to U0-xx U3-00 to U3-xx	0	-	☆
FE-25	User-defined parameter 25	F0-00 to FP-xx A0-00 to Ax-xx U0-xx to U0-xx U3-00 to U3-xx	0	-	☆
FE-26	User-defined parameter 26	F0-00 to FP-xx A0-00 to Ax-xx U0-xx to U0-xx U3-00 to U3-xx	0	-	☆
FE-27	User-defined parameter 27	F0-00 to FP-xx A0-00 to Ax-xx U0-xx to U0-xx U3-00 to U3-xx	0	-	☆
FE-28	User-defined parameter 28	F0-00 to FP-xx A0-00 to Ax-xx U0-xx to U0-xx U3-00 to U3-xx	0	-	☆

Parameters

Para. No.	Name	Value Range	Default	Unit	Property
FE-29	User-defined parameter 29	F0-00 to FP-xx A0-00 to Ax-xx U0-xx to U0-xx U3-00 to U3-xx	0	-	☆
FE-30	User-defined parameter 30	F0-00 to FP-xx A0-00 to Ax-xx U0-xx to U0-xx U3-00 to U3-xx	0	-	☆
FE-31	User-defined parameter 31	F0-00 to FP-xx A0-00 to Ax-xx U0-xx to U0-xx U3-00 to U3-xx	0	-	☆
Group FP: User Parameters					
FP-00	User password	0–65535	0	-	●
FP-01	Parameter initialization	0: No action 1: Restore default settings (mode 1) 2: Clear records 4: Back up current user parameters 501: Restore user backup parameters 503: Restore default settings (mode 2)	1	-	☆
FP-02	Parameter group display	Ones (position): Group U display 0: Hide 1: Display Tens (position): Group A display 0: Hide 1: Display Hundreds (position): Group B display 0: Hide 1: Display Thousands (position): Group C display 0: Hide 1: Display	111	-	☆
FP-03	User parameter group display	Ones (position): User-defined parameter group display 0: Hide 1: Display Tens (position): User-modified parameter group display 0: Hide 1: Display	11	-	☆
FP-04	Parameter modification property	0: Modifiable 1: Not modifiable	0	-	☆
Group A0: Torque Control and Restricting Parameters					
A0-00	Speed/Torque control mode	0: Speed control 1: Torque control	0	-	★

Para. No.	Name	Value Range	Default	Unit	Property
A0-01	Torque reference source	0: Digital setting of drive torque upper limit (A0-03) 1: AI1 2: AI2 3: AI3 4: Reserved 5: Communication setting (1000H) 6: Min. (AI1, AI2) 7: Max. (AI1, AI2)	0	-	★
A0-03	Torque digital setting	-200.0% to +200.0%	100.0%	%	☆
A0-04	Torque filter time	0.000–5.000s	0.000s	s	☆
A0-05	Speed limit digital setting	-120.0% to 120.0%	0.0%	%	☆
A0-06	Frequency modulation coefficient in window mode	0.0–50.0	0.0	-	☆
A0-07	Acceleration time (torque)	0.00–650.00s	1.00s	s	☆
A0-08	Deceleration time (torque)	0.00–650.00s	1.00s	s	☆
A0-09	Speed limit reference source	0: A0-05 1: Frequency source	0	-	☆
A0-10	Speed limit offset/ Windows frequency	0 to the maximum frequency (F0-10)	5.00	-	☆
A0-11	Effective mode of speed limit offset	0: Bidirectional offset valid 1: Unidirectional offset valid 2: Windows mode	1	-	★
A0-12	Acceleration time (frequency)	0.0–6500.0s	1.0s	s	☆
A0-13	Deceleration time (frequency)	0.0–6500.0s	1.0s	s	☆
A0-14	Torque mode switchover	0: No switchover 1: Switched to speed control at stop 2: Target torque at stop being 0	1	-	★
Group A1: Virtual DI/DO Parameters					
A1-00	VDI1 function selection	Same as F4-00	0	-	★
A1-01	VDI2 function selection	Same as F4-00	0	-	★
A1-02	VDI3 function selection	Same as F4-00	0	-	★
A1-03	VDI4 function selection	Same as F4-00	0	-	★
A1-04	VDI5 function selection	Same as F4-00	0	-	★

Parameters

Para. No.	Name	Value Range	Default	Unit	Property
A1-05	VDI active state source	Ones (position): 0: Parameter setting (A1-06) 1: DO state 2: DI state Tens (position): 0: Parameter setting (A1-06) 1: DO state 2: DI state Hundred (position): 0: Parameter setting (A1-06) 1: DO state 2: DI state Thousands (position): 0: Parameter setting (A1-06) 1: DO state 2: DI state Ten thousands (position): 0: Parameter setting (A1-06) 1: DO state 2: DI state	0	-	★
A1-06	Selection of VDI active state	Ones (position): 0: Inactive 1: Active Tens (position): 0: Inactive 1: Active Hundreds (position): 0: Inactive 1: Active Thousands (position): 0: Inactive 1: Active Ten thousands (position): 0: Inactive 1: Active	0	-	☆
A1-07	Function selection for AI1 used as DI	Same as F4-00	0	-	★
A1-08	Function selection for AI2 used as DI	Same as F4-00	0	-	★
A1-09	Function selection for AI3 used as DI	Same as F4-00	0	-	★

Para. No.	Name	Value Range	Default	Unit	Property
A1-10	Active mode selection (AI as DI)	Ones (position): 0: Active high 1: Active low Tens (position): 0: Active high 1: Active low Hundreds (position): 0: Active high 1: Active low	0	-	★
A1-11	VDO1 function selection	0: No output 1: AC drive running 2: Fault output (stop at fault) 3: Frequency level detection FDT1 output 4: Frequency reach 5: Zero-speed running (no output at stop) 6: Motor overload pre-warning 7: AC drive overload pre-warning 8: Set count value reach 9: Designated count value reach 10: Length reach 11: PLC cycle completed 12: Accumulative running time reach 13: Frequency limited 14: Torque limited 15: Ready to run 16: AI1 > AI2 17: Frequency upper limit reach 18: Frequency lower limit reach (operation related) 19: Undervoltage output 20: Communication 21: Reserved 22: Reserved 23: Zero-speed running 2 (at stop) 24: Accumulative power-on time reach 25: Frequency level detection FDT2 output 26: Frequency 1 reach 27: Frequency 2 reach 28: Current 1 reach 29: Current 2 reach 30: Timing reach 31: AI1 input limit exceeded 32: Output load loss	0	-	☆

Para. No.	Name	Value Range	Default	Unit	Property
(continued)	(continued)	33: Reverse run 34: Zero current state 35: IGBT temperature reach 36: Output current limit exceeded 37: Frequency lower limit reach (having output at stop) 38: Alarm output (direct output at fault or alarm) 39: Current over-temperature pre-warning 40: Current running time reach 41: Fault output 2 42: Fault output 3 43: Position lock succeeded 46: Brake release output	0	-	☆
A1-12	VDO2 function selection	Same as A1-11	0	-	☆
A1-13	VDO3 function selection	Same as A1-11	0	-	☆
A1-14	VDO4 function selection	Same as A1-11	0	-	☆
A1-15	VDO5 function selection	Same as A1-11	0	-	☆
A1-16	VDO1 output delay	0.0–3600.0s	0.0s	s	☆
A1-17	VDO2 output delay	0.0–3600.0s	0.0s	s	☆
A1-18	VDO3 output delay	0.0–3600.0s	0.0s	s	☆
A1-19	VDO4 output delay	0.0–3600.0s	0.0s	s	☆
A1-20	VDO5 output delay	0.0–3600.0s	0.0s	s	☆
A1-21	VDO active mode selection	Ones (position): VDO1 0: Positive logic 1: Negative logic Tens (position): VDO2 0: Positive logic 1: Negative logic Hundreds (position): VDO3 0: Positive logic 1: Negative logic Thousands (position): VDO4 0: Positive logic 1: Negative logic Ten thousands (position): VDO5 0: Positive logic 1: Negative logic	0	-	☆
Group A5: Control Optimization Parameters					
A5-00	DPWM switchover frequency upper limit	0 to the maximum frequency (F0-10)	12.00 Hz	Hz	☆

Para. No.	Name	Value Range	Default	Unit	Property
A5-01	PWM modulation mode	0: Asynchronous modulation 1: Reserved 2: Synchronous modulation mode 2 3: Synchronous modulation mode 3	0	-	☆
A5-02	Dead-zone compensation mode selection	0: No compensation 1: Compensation mode 1 2: Compensation mode 2	2	-	★
A5-03	Random PWM depth	0–10	0	-	☆
A5-04	Fast current limit	0: Disabled 1: Enabled	0	-	☆
A5-05	Sampling delay	1–13	5	-	☆
A5-06	Undervoltage threshold	150.0–700.0 V	350.0 V	V	☆
A5-07	SVC optimization selection	0: No optimization 1: Optimization mode 1 2: Optimization mode 2	1	-	★
A5-08	Dead-zone time adjustment (reserved)	100% to 200%	150%	%	★
A5-09	Overmodulation selection (reserved)	0: Not start 1: Start	0	-	●
A5-10	Narrow pulse control selection (reserved)	0: Not start 1: Start	0	-	●
A5-11	Switching frequency and modulation optimization selection	Ones (position): 0: DPWM (5-segment SVPWM) or CPWM (7-segment SVPWM) selected automatically based on the frequency specified by A5-00 1: CPWM Tens (position): Reserved	10	-	☆
A5-13	Bus voltage in function part	100–20000	5310	-	●
A5-14	Temperature correction	0: Disabled 1: Enabled	0	-	★
A5-16	Display parameter address 1	0–100	0	-	●
A5-17	Display parameter address 2	0–100	1	-	●
A5-18	Display parameter address 3	0–100	2	-	●
A5-19	Display parameter address 4	0–100	3	-	●
A5-21	Low speed carrier frequency	0.0–16.0	0.0	-	☆

Parameters

Para. No.	Name	Value Range	Default	Unit	Property
A5-22	Dead-zone compensation auto-tuning	0: Disabled 1: Enabled	0 (synchronous motor) 1 (asynchronous motor)	-	★
Group A6: AI Curve Setting Parameters					
A6-00	Curve 4 minimum input	-10.00 V to value of A6-02	0.00 V	V	☆
A6-01	Percentage corresponding to curve 4 minimum input	-100.0% to +100.0%	0.0%	%	☆
A6-02	Curve 4 inflexion point 1 input	Value of A6-00 to value of A6-04	3.00 V	V	☆
A6-03	Percentage corresponding to curve 4 inflexion point 1 input	-100.0% to +100.0%	30.0%	%	☆
A6-04	Curve 4 inflexion point 2 input	Value of A6-02 to value of A6-06	6.00 V	V	☆
A6-05	Percentage corresponding to curve 4 inflexion point 2 input	-100.0% to +100.0%	60.0%	%	☆
A6-06	Curve 4 maximum input	Value of A6-04 to 10.00 V	10.00 V	V	☆
A6-07	Percentage corresponding to curve 4 maximum input	-100.0% to +100.0%	100.0%	%	☆
A6-08	Curve 5 minimum input	-10.00 V to value of A6-10	-10.00 V	V	☆
A6-09	Percentage corresponding to curve 5 minimum input	-100.0% to +100.0%	-100.0%	%	☆
A6-10	Curve 5 inflexion point 1 input	Value of A6-08 to value of A6-12	-3.00 V	V	☆
A6-11	Percentage corresponding to curve 5 inflexion point 1 input	-100.0% to +100.0%	-30.0%	%	☆
A6-12	Curve 5 inflexion point 2 input	Value of A6-10 to value of A6-14	3.00 V	V	☆
A6-13	Percentage corresponding to curve 5 inflexion point 2 input	-100.0% to +100.0%	30.0%	%	☆
A6-14	Curve 5 maximum input	Value of A6-12 to 10.00 V	10.00 V	V	☆
A6-15	Percentage corresponding to curve 5 maximum input	-100.0% to +100.0%	100.0%	%	☆
A6-16	AI1 gain	-10.00 to +10.00	1.00	-	☆
A6-17	AI1 offset	-100.0% to +100.0%	0.0%	%	☆
A6-18	AI2 gain	-10.00 to +10.00	1.00	-	☆

Para. No.	Name	Value Range	Default	Unit	Property
A6-19	AI2 offset	-100.0% to +100.0%	0.0%	%	☆
A6-20	AI3 gain	-10.00 to +10.00	1.00	-	☆
A6-21	AI3 offset	-100.0% to +100.0%	0.0%	%	☆
A6-22	AI encoder disconnection detection threshold	0.0% to 100.0%	0.0%	%	☆
A6-23	AI encoder disconnection detection time	0.0-6553.5s	0.0s	s	☆
A6-24	Jump point of AI1 setting	-100.0% to +100.0%	0.0%	%	☆
A6-25	Jump amplitude of AI1 setting	0.0% to 100.0%	0.1%	%	☆
A6-26	Jump point of AI2 setting	-100.0% to +100.0%	0.0%	%	☆
A6-27	Jump amplitude of AI2 setting	0.0% to 100.0%	0.1%	%	☆
A6-28	Jump point of AI3 setting	-100.0% to +100.0%	0.0%	%	☆
A6-29	Jump amplitude of AI3 setting	0.0% to 100.0%	0.1%	%	☆
Group A9: Vector Control Supplementary Parameters					
A9-00	Online auto-tuning on the rotor time constant of the asynchronous motor	0: Disabled 1: Enabled	0	-	☆
A9-01	Rotor resistance gain for asynchronous motor auto-tuning in FVC mode	0-100	5	-	☆
A9-02	Rotor resistance start frequency for asynchronous motor auto-tuning in FVC mode	2-100 Hz	7 Hz	Hz	☆
A9-03	Magnetic field efficient for asynchronous motor observation in FVC mode	30-150	40	-	☆
A9-04	Maximum torque limit coefficient for the asynchronous motor field-weakening range	30-150	80	-	☆
A9-05	Speed filter of asynchronous motor in SVC mode	5-32 ms	15 ms	ms	☆

Parameters

Para. No.	Name	Value Range	Default	Unit	Property
A9-06	Asynchronous motor speed feedback handling in SVC mode	0: No operation 1: Minimum synchronization frequency limited based on load change 2: Fixed current output during low-speed running 3: Fixed current output during low-speed running	0	-	☆
A9-07	Magnetic field regulation bandwidth of asynchronous motor in SVC mode	0.0–8.0	2.0	-	☆
A9-08	Low-speed running current of asynchronous motor in SVC mode	30–170	100	-	☆
A9-09	Switchover frequency of output fixed current of asynchronous motor in SVC mode	2.0–100.0 Hz	7.0 Hz	Hz	☆
A9-10	Coefficient of speed fluctuation for suppression of asynchronous motor in SVC mode	0–6	3	-	☆
A9-11	Acceleration/Deceleration time of asynchronous motor in SVC mode	0.1–3000.0s	50.0s	s	☆
A9-12	Quick auto-tuning of stator resistance before asynchronous motor startup	0: Disabled 1: Enabled	0	-	☆
A9-13	Quick auto-tuning of stator resistance coefficient 1 of asynchronous motor	0–65535	10	-	★
A9-14	Quick auto-tuning of stator resistance coefficient 2 of asynchronous motor	0–65535	10	-	★
A9-15	Quick auto-tuning of stator resistance coefficient 3 of asynchronous motor	0–65535	0	-	★
A9-17	Synchronous motor real-time angle	0.0–359.9	0.0	-	●

Para. No.	Name	Value Range	Default	Unit	Property
A9-18	Initial angle detection of synchronous motor	0: Detected every run 1: Not detected 2: Detected upon initial power-on	0	-	☆
A9-20	Flux weakening mode selection	0: Automatic mode 1: Synchronous motor adjustment mode 2: Synchronous motor hybrid mode 3: Disabled	1	-	★
A9-21	Flux weakening gain of synchronous motor	0–50	5	-	☆
A9-22	Output voltage upper limit margin of synchronous motor	0% to 50%	5%	%	☆
A9-23	Maximum force adjustment gain of synchronous motor	20% to 300%	100%	%	☆
A9-24	Exciting current adjustment gain calculated by synchronous motor	40% to 200%	100%	%	☆
A9-25	Estimated synchronous motor speed integral gain in SVC mode	5% to 1000%	30%	%	☆
A9-26	Estimated synchronous motor speed proportional gain in SVC mode	5% to 300%	20%	%	☆
A9-27	Estimated synchronous motor speed filter in SVC mode	10–2000	100	-	☆
A9-28	Minimum carrier frequency of synchronous motor in SVC mode	0.8 to value of F0-15	2.0	-	☆
A9-29	Low speed excitation current of synchronous motor in SVC mode	0% to 80%	30%	%	☆
A9-35	Performance fault subcode upon 1st fault	0–65535	0	-	●
A9-36	Performance fault subcode upon 2nd fault	0–65535	0	-	●
A9-37	Performance fault subcode upon 3rd fault	0–65535	0	-	●
A9-40	Low-speed closed-loop current selection (PMVVC)	0: Disabled 1: Enabled	0	-	★

Parameters

Para. No.	Name	Value Range	Default	Unit	Property
A9-41	Low-speed closed-loop current (PMVC)	30% to 200%	50%	%	★
A9-42	Oscillation suppression damping coefficient (PMVC)	0% to 500%	100%	%	☆
A9-43	Initial position compensation angle (PMVC)	0–5	0	-	★
A9-44	Initial position compensation angle of synchronous motor	0.0–360.0	0.0	-	☆
A9-45	Synchronous motor low-speed handling	0: Disabled 1: Enabled	0	-	★
A9-46	Switchover frequency for synchronous motor low-speed handling	0.01 Hz to the maximum frequency (F0-10)	5.00	Hz	★
A9-47	Synchronous motor low-speed handling current	10–200	100	-	★
A9-48	Synchronous motor low-speed handling feedback suppression coefficient	0–300	32	-	★
A9-49	Synchronous motor energy-saving control	0: Disabled 1: Enabled	0	-	★
A9-50	Maximum flux weakening current limit margin	200–1000	1000	-	★
A9-51	Advanced settings for asynchronous motor parameter auto-tuning	Ones (position): 1: Rotor resistance and leakage inductance DC offset selection Tens (position) 1: New rotor resistance and leakage inductance auto-tuning algorithm Hundreds (position): 1: New mutual inductance static auto-tuning algorithm	111	-	★
A9-52	U0-06 feedback torque selection	0: Motoring torque being positive and generating torque being negative 1: Torque direction being positive in the case of positive speed direction; torque direction being negative in the case of negative speed direction	1	-	☆
A9-54	Transistor voltage drop	0–10000	700	-	★
A9-55	Dead-zone time 0	0–10000	352	-	★
A9-56	Dead-zone time 1	0–10000	1052	-	★

Para. No.	Name	Value Range	Default	Unit	Property
A9-57	Dead-zone time 2	0–10000	1270	-	★
A9-58	Dead-zone time 3	0–10000	1358	-	★
A9-59	Dead-zone time 4	0–10000	1404	-	★
A9-60	Dead-zone time 5	0–10000	1449	-	★
A9-61	Dead-zone time 6	0–10000	1661	-	★
A9-62	Dead-zone time 7	0–10000	1689	-	★
A9-63	Dead-zone compensation current 0	0–10000	94	-	★
A9-64	Dead-zone compensation current 1	0–10000	376	-	★
A9-65	Dead-zone compensation current 2	0–10000	658	-	★
A9-66	Dead-zone compensation current 3	0–10000	940	-	★
A9-67	Dead-zone compensation current 4	0–10000	1222	-	★
A9-68	Dead-zone compensation current 5	0–10000	1504	-	★
A9-69	Dead-zone compensation current 6	0–10000	3478	-	★
A9-70	Dead-zone compensation current 7	0–10000	5452	-	★
Group AC: AI/AO Correction Parameters					
AC-00	AI1 measured voltage 1	–10.000 V to +10.000 V	Corrected before delivery	V	☆
AC-01	AI1 displayed voltage 1	–10.000 V to +10.000 V	Corrected before delivery	V	☆
AC-02	AI1 measured voltage 2	–10.000 V to +10.000 V	Corrected before delivery	V	☆
AC-03	AI1 displayed voltage 2	–10.000 V to +10.000 V	Corrected before delivery	V	☆
AC-04	AI2 measured voltage 1	–10.000 V to +10.000 V	Corrected before delivery	V	☆
AC-05	AI2 displayed voltage 1	–10.000 V to +10.000 V	Corrected before delivery	V	☆
AC-06	AI2 measured voltage 2	–10.000 V to +10.000 V	Corrected before delivery	V	☆
AC-07	AI2 displayed voltage 2	–10.000 V to +10.000 V	Corrected before delivery	V	☆
AC-08	AI3 measured voltage 1	–10.000 V to +10.000 V	Corrected before delivery	V	☆
AC-09	AI3 displayed voltage 1	–10.000 V to +10.000 V	Corrected before delivery	V	☆

Parameters

Para. No.	Name	Value Range	Default	Unit	Property
AC-10	AI3 measured voltage 2	-10.000 V to +10.000 V	Corrected before delivery	V	☆
AC-11	AI3 displayed voltage 2	-10.000 V to +10.000 V	Corrected before delivery	V	☆
AC-12	AO1 measured voltage 1	-10.000 V to +10.000 V	Corrected before delivery	V	☆
AC-13	AO1 target voltage 1	-10.000 V to +10.000 V	Corrected before delivery	V	☆
AC-14	AO1 measured voltage 2	-10.000 V to +10.000 V	Corrected before delivery	V	☆
AC-15	AO1 target voltage 2	-10.000 V to +10.000 V	Corrected before delivery	V	☆
AC-16	AO2 measured voltage 1	-10.000 V to +10.000 V	Corrected before delivery	V	☆
AC-17	AO2 target voltage 1	-10.000 V to +10.000 V	Corrected before delivery	V	☆
AC-18	AO2 measured voltage 2	-10.000 V to +10.000 V	Corrected before delivery	V	☆
AC-19	AO2 target voltage 2	-10.000 V to +10.000 V	Corrected before delivery	V	☆
AC-28	AO1 measured current 1	0.000-20.000 mA	4.000 mA	mA	☆
AC-29	AO1 target current 1	0.000-20.000 mA	4.000 mA	mA	☆
AC-30	AO1 measured current 2	0.000-20.000 mA	16.000 mA	mA	☆
AC-31	AO1 target current 2	0.000-20.000 mA	16.000 mA	mA	☆
Group AF: Process Data Address Mapping Parameters					
AF-00	RPDO1-SubIndex0-H	0-65535	0	-	☆
AF-01	RPDO1-SubIndex0-L	0-65535	0	-	☆
AF-02	RPDO1-SubIndex1-H	0-65535	0	-	☆
AF-03	RPDO1-SubIndex1-L	0-65535	0	-	☆
AF-04	RPDO1-SubIndex2-H	0-65535	0	-	☆
AF-05	RPDO1-SubIndex2-L	0-65535	0	-	☆
AF-06	RPDO1-SubIndex3-H	0-65535	0	-	☆
AF-07	RPDO1-SubIndex3-L	0-65535	0	-	☆
AF-08	RPDO2-SubIndex0-H	0-65535	0	-	☆
AF-09	RPDO2-SubIndex0-L	0-65535	0	-	☆
AF-10	RPDO2-SubIndex1-H	0-65535	0	-	☆
AF-11	RPDO2-SubIndex1-L	0-65535	0	-	☆
AF-12	RPDO2-SubIndex2-H	0-65535	0	-	☆
AF-13	RPDO2-SubIndex2-L	0-65535	0	-	☆
AF-14	RPDO2-SubIndex3-H	0-65535	0	-	☆
AF-15	RPDO2-SubIndex3-L	0-65535	0	-	☆
AF-16	RPDO3-SubIndex0-H	0-65535	0	-	☆

Para. No.	Name	Value Range	Default	Unit	Property
AF-17	RPDO3-SubIndex0-L	0-65535	0	-	☆
AF-18	RPDO3-SubIndex1-H	0-65535	0	-	☆
AF-19	RPDO3-SubIndex1-L	0-65535	0	-	☆
AF-20	RPDO3-SubIndex2-H	0-65535	0	-	☆
AF-21	RPDO3-SubIndex2-L	0-65535	0	-	☆
AF-22	RPDO3-SubIndex3-H	0-65535	0	-	☆
AF-23	RPDO3-SubIndex3-L	0-65535	0	-	☆
AF-24	RPDO4-SubIndex0-H	0-65535	0	-	☆
AF-25	RPDO4-SubIndex0-L	0-65535	0	-	☆
AF-26	RPDO4-SubIndex1-H	0-65535	0	-	☆
AF-27	RPDO4-SubIndex1-L	0-65535	0	-	☆
AF-28	RPDO4-SubIndex2-H	0-65535	0	-	☆
AF-29	RPDO4-SubIndex2-L	0-65535	0	-	☆
AF-30	RPDO4-SubIndex3-H	0-65535	0	-	☆
AF-31	RPDO4-SubIndex3-L	0-65535	0	-	☆
AF-32	TPDO1-SubIndex0-H	0-65535	0	-	☆
AF-33	TPDO1-SubIndex0-L	0-65535	0	-	☆
AF-34	TPDO1-SubIndex1-H	0-65535	0	-	☆
AF-35	TPDO1-SubIndex1-L	0-65535	0	-	☆
AF-36	TPDO1-SubIndex2-H	0-65535	0	-	☆
AF-37	TPDO1-SubIndex2-L	0-65535	0	-	☆
AF-38	TPDO1-SubIndex3-H	0-65535	0	-	☆
AF-39	TPDO1-SubIndex3-L	0-65535	0	-	☆
AF-40	TPDO2-SubIndex0-H	0-65535	0	-	☆
AF-41	TPDO2-SubIndex0-L	0-65535	0	-	☆
AF-42	TPDO2-SubIndex1-H	0-65535	0	-	☆
AF-43	TPDO2-SubIndex1-L	0-65535	0	-	☆
AF-44	TPDO2-SubIndex2-H	0-65535	0	-	☆
AF-45	TPDO2-SubIndex2-L	0-65535	0	-	☆
AF-46	TPDO2-SubIndex3-H	0-65535	0	-	☆
AF-47	TPDO2-SubIndex3-L	0-65535	0	-	☆
AF-48	TPDO3-SubIndex0-H	0-65535	0	-	☆
AF-49	TPDO3-SubIndex0-L	0-65535	0	-	☆
AF-50	TPDO3-SubIndex1-H	0-65535	0	-	☆
AF-51	TPDO3-SubIndex1-L	0-65535	0	-	☆
AF-52	TPDO3-SubIndex2-H	0-65535	0	-	☆
AF-53	TPDO3-SubIndex2-L	0-65535	0	-	☆
AF-54	TPDO3-SubIndex3-H	0-65535	0	-	☆
AF-55	TPDO3-SubIndex3-L	0-65535	0	-	☆
AF-56	TPDO4-SubIndex0-H	0-65535	0	-	☆
AF-57	TPDO4-SubIndex0-L	0-65535	0	-	☆
AF-58	TPDO4-SubIndex1-H	0-65535	0	-	☆
AF-59	TPDO4-SubIndex1-L	0-65535	0	-	☆

Parameters

Para. No.	Name	Value Range	Default	Unit	Property
AF-60	TPDO4-SubIndex2-H	0-65535	0	-	☆
AF-61	TPDO4-SubIndex2-L	0-65535	0	-	☆
AF-62	TPDO4-SubIndex3-H	0-65535	0	-	☆
AF-63	TPDO4-SubIndex3-L	0-65535	0	-	☆
AF-66	Number of valid RPDOs	0-65535	0	-	☆
AF-67	Number of valid TPDOs	0-65535	0	-	☆
Group B0: Control Mode, Linear Speed, and Roll Diameter Parameters					
B0-00	Tension control mode	0: Disabled 1: Open loop torque control 2: Closed loop speed control 3: Closed loop torque control 4: Constant linear speed control	0	-	★
B0-01	Winding mode	0: Winding 1: Unwinding	0	-	☆
B0-02	Unwinding reverse tightening selection	0: Disabled 0.1-500.0 m/min	0.0 m/min	m/min	☆
B0-03	Mechanical transmission ratio	0.00-300.00	1.00	-	☆
B0-04	Linear speed input source	0: No output 1: AI1 2: AI2 3: AI3 4: Pulse input (DI5) 5: Communication(1000H)	0	-	★
B0-05	Maximum linear speed	0.0-6500.0 m/min	1000.0 m/min	m/min	☆
B0-06	Minimum linear speed for winding diameter calculation	0.0-6500.0 m/min	20.0 m/min	m/min	☆
B0-07	Roll diameter calculation method	0: Calculated based on linear speed 1: Calculated based on accumulative thickness 2: AI1 3: AI2 4: AI3 5: Pulse input (DI5) 6: Communication 7: Specified by B0-14	0	-	★
B0-08	Maximum roll diameter	0.1-6000.0 mm	500.0 mm	mm	☆
B0-09	Reel diameter	0.1-6000.0 mm	100.0 mm	mm	☆
B0-10	Initial roll diameter source	0: Specified by B0-11 to B0-13 1: AI1 2: AI2 3: AI3 4: Communication	0	-	★
B0-11	Initial roll diameter 1	0.1-6000.0 mm	100.0 mm	mm	☆
B0-12	Initial roll diameter 2	0.1-6000.0 mm	100.0 mm	mm	☆

Para. No.	Name	Value Range	Default	Unit	Property
B0-13	Initial roll diameter 3	0.1–6000.0 mm	100.0 mm	mm	☆
B0-14	Current roll diameter	0.1–6000.0 mm	100.0 mm	mm	☆
B0-15	Roll diameter filter time	0.00–10.00s	5.00s	s	☆
B0-16	Winding diameter change rate	0.0–1000.0	0.0	-	☆
B0-17	Roll diameter change direction limit	0: Disabled 1: Decrease disabled during winding, and increase disabled during unwinding	0	-	☆
B0-18	Roll diameter reset during running	0–1	0	-	☆
B0-19	Pre-charge frequency gain	–100.0% to +100.0%	0.0%	%	☆
B0-20	Pre-charge torque limit source	0: Based on the value of F2-09 1: Based on tension control torque	1	-	★
B0-21	Pre-charge torque correction	–100.0% to +100.0%	0.0	%	☆
B0-22	Pre-charge roll diameter calculation delay (reserved)	0.1–6500.0s	10.0s	s	☆
B0-23	Pre-charge acceleration time	0.0–6000.0s	20.0s	s	☆
B0-24	Pre-charge deceleration time	0.0–6000.0s	20.0s	s	☆
B0-25	Pre-charge roll diameter calculation function	0: Disabled 1: Enabled	0	-	☆
B0-26	Winding frequency limit	0.0% to 100.0%	50.0	%	☆
B0-27	Winding frequency limit offset	0.00–100.00 Hz	5.00 Hz	Hz	☆
B0-28	B0-00 set to 2: close-loop speed control range limit selection B0-00 not set to 2: limit for the winding frequency upper limit	B0-00 set to 2: 0: Limited based on the values of B0-26 and B0-27 (subject to the frequency upper limit) 1: Limited to the value of B0-27 B0-00 not set to 2: 0: Disabled (subject to the frequency upper limit) 1: Limited based on the values of B0-26 and B0-27	0	-	☆
B0-29	Pulses per revolution	1–60000	1	-	☆
B0-30	Revolutions per layer	1–10000	1	-	☆
B0-31	Material thickness reference source	0: Digital setting 1: A1 2: A2 3: A3	0	-	☆

Parameters

Para. No.	Name	Value Range	Default	Unit	Property
B0-32	Material thickness 0	0.01–100.00 mm	0.01 mm	mm	☆
B0-33	Material thickness 1	0.01–100.00 mm	0.01 mm	mm	☆
B0-34	Material thickness 2	0.01–100.00 mm	0.01 mm	mm	☆
B0-35	Material thickness 3	0.01–100.00 mm	0.01 mm	mm	☆
B0-36	Maximum thickness	0.01–100.00 mm	1.00 mm	mm	☆
B0-38	Closed-loop speed control limit selection	0: Torque calculated through PID only 1: Torque calculated through main + PID	0	-	★
B0-40	Minimum torque limit in pre-charge mode	0.0% to 100.0%	0.0%	%	☆
B0-41	Constant linear speed input source	0: AI1 1: AI2 2: AI3 3: Pulse reference (DI5) 4: Communication	0	-	★
Group B1: Tension Reference Parameters					
B1-00	Tension reference source	0: Specified by B0-01 1: AI1 2: AI2 3: AI3 4: Pulse reference (DI5) 5: Communication	0	-	★
B1-01	Tension digital setting	0–65000	50 N	N	☆
B1-02	Maximum tension	0–65000	500 N	N	☆
B1-03	Zero-speed threshold	0.0% to 20.0%	0.0%	%	☆
B1-04	Zero-speed tension rise	0.0% to 100.0%	0.0%	%	☆
B1-05	Frequency acceleration time in torque control mode	0.0–6500.0s	0.0s	s	☆
B1-06	Frequency deceleration time in torque control mode	0.0–6500.0s	0.0s	s	☆
B1-07	Friction force compensation	0.0% to 50.0%	0.0%	%	☆
B1-08	Mechanical inertia compensation coefficient	0–65535 N•m ²	0 N•m ²	N•m ²	☆
B1-09	Acceleration inertia compensation gain	0.0% to 200.0%	100.0%	%	☆
B1-10	Deceleration inertia compensation gain	0.0% to 200.0%	100.0%	%	☆
B1-11	Material density	0–65535 kg/m ³	0 kg/m ³	kg/m ³	☆
B1-12	Material width	0–65535 mm	0 mm	mm	☆
B1-13	Inertia compensation exit delay	0–100 ms	0 ms	ms	☆

Para. No.	Name	Value Range	Default	Unit	Property
B1-14	Transition frequency for zero speed compensation	0.00–200.00 Hz	2.00 Hz	Hz	☆
B1-15	Open-loop torque reverse	0: Disabled 1: Enabled	0	-	☆
B1-16	Tension closed-loop torque control limit	0.0% to 200.0%	100.0	%	☆
B1-17	Friction force compensation correction coefficient	–50.0 to +50.0	0.0	-	☆
B1-18	Friction force compensation curve	0: Compensate based on linear speed synchronous frequency 1: Compensate based on linear speed 2: Multi-friction compensation curve 1 3: Multi-friction compensation curve 2	0	-	★
B1-19	Multi-friction force compensation torque 1	0.0–50.0	0.0	-	☆
B1-20	Multi-friction force compensation torque 2	0.0–50.0	0.0	-	☆
B1-21	Multi-friction force compensation torque 3	0.0–50.0	0.0	-	☆
B1-22	Multi-friction force compensation torque 4	0.0–50.0	0.0	-	☆
B1-23	Multi-friction force compensation torque 5	0.0–50.0	0.0	-	☆
B1-24	Multi-friction force compensation torque 6	0.0–50.0	0.0	-	☆
B1-25	Multi-friction force compensation inflection point 1	0 to the maximum frequency (F0-10)	0.00 Hz	Hz	☆
B1-26	Multi-friction force compensation inflection point 2	0 to the maximum frequency (F0-10)	0.00 Hz	Hz	☆
B1-27	Multi-friction force compensation inflection point 3	0 to the maximum frequency (F0-10)	0.00 Hz	Hz	☆
B1-28	Multi-friction force compensation inflection point 4	0 to the maximum frequency (F0-10)	0.00 Hz	Hz	☆
B1-29	Multi-friction force compensation inflection point 5	0 to the maximum frequency (F0-10)	0.00 Hz	Hz	☆
B1-30	Multi-friction force compensation inflection point 6	0 to the maximum frequency (F0-10)	0.00 Hz	Hz	☆

Parameters

Para. No.	Name	Value Range	Default	Unit	Property
B1-31	Tension setup at pre-speed	0: Disabled 1: Enabled	0	-	★
B1-32	Tension setup dead zone	0.0% to 100.0%	2.0%	%	☆
B1-33	Pre-speed of tension setup	0.00 Hz to value of F0-10	0.10 Hz	Hz	☆
B1-34	Terminal tension rise ratio	0.0% to 500.0%	50.0	-	☆
B1-35	Rise revocation transition time	0.0–50.0s	0.0	-	☆
B1-37	Initial roll diameter auto-tuning selection	0: Disabled 1: Enabled	0	-	★
B1-38	Rod length	1–65535 mm	300 mm	mm	★
B1-39	Rod angle	0.1° to 360°	40.0°	°	★
Group B2: Taper Parameters					
B2-00	Taper curve selection	0: Curve 1: Linear	0	-	★
B2-01	Tension taper source selection	0: Specified by B2 02 1: AI1 2: AI2 3: AI3 4: Communication(1000H)	0	-	★
B2-02	Digital setting of taper	0.0% to 100.0%	0.0%	%	☆
B2-03	Correction coefficient of taper compensation	0–10000 mm	0 mm	mm	☆
B2-04	Closed-loop tension taper selection (reserved)	0: Enabled 1: Disabled	0	-	★
B2-05	Maximum external taper source	0: Specified by B2-06 1: AI1 2: AI2 3: AI3 4: Communication	0	-	★
B2-06	Maximum external taper setting	0.0% to 100.0%	100.0%	%	☆
B2-07	Number of straight taper inflexion points (reserved)	0–5	5	-	☆
B2-08	Taper at minimum roll diameter	0.0% to 100.0%	100.0	%	☆
B2-09	Linear taper switchover point 1	Value of B0-09 to value of B0-08	150.0	-	☆
B2-10	Taper of switchover point 1	0.0% to 100.0%	100.0	%	☆

Para. No.	Name	Value Range	Default	Unit	Property
B2-11	Linear taper switchover point 2	Value of B2-09 to value of B0-08	200.0	-	☆
B2-12	Taper of switchover point 2	0.0% to 100.0%	90.0	%	☆
B2-13	Linear taper switchover point 3	Value of B2-11 to value of B0-08	250.0	-	☆
B2-14	Taper of switchover point 3	0.0% to 100.0%	80.0	%	☆
B2-15	Linear taper switchover point 4	Value of B2-13 to value of B0-08	300.0	-	☆
B2-16	Taper of switchover point 4	0.0% to 100.0%	70.0	%	☆
B2-17	Linear taper switchover point 5	Value of B2-15 to value of B0-08	400.0	-	☆
B2-18	Taper of switchover point 5	0.0% to 100.0%	50.0	%	☆
B2-19	Taper at maximum roll diameter	0.0% to 100.0%	30.0	%	☆
Group B6: Communication Free Mapping Configuration					
B6-00	Source address 1	0–57362	0	-	☆
B6-01	Mapping address 1	0–20494	0	-	☆
B6-02	Write gain 1	0.00–100.00	10.00	-	☆
B6-03	Read gain 1	0.00–100.00	0.10	-	☆
B6-04	Source address 2	0–65535	0	-	☆
B6-05	Mapping address 2	0–65535	0	-	☆
B6-06	Write gain 2	0.00–100.00	0.00	-	☆
B6-07	Read gain 2	0.00–100.00	0.00	-	☆
B6-08	Source address 3	0–65535	0	-	☆
B6-09	Mapping address 3	0–65535	0	-	☆
B6-10	Write gain 3	0.00–100.00	0.00	-	☆
B6-11	Read gain 3	0.00–100.00	0.00	-	☆
B6-12	Source address 4	0–65535	0	-	☆
B6-13	Mapping address 4	0–65535	0	-	☆
B6-14	Write gain 4	0.00–100.00	0.00	-	☆
B6-15	Read gain 4	0.00–100.00	0.00	-	☆
B6-16	Source address 5	0–65535	0	-	☆
B6-17	Mapping address 5	0–65535	0	-	☆
B6-18	Write gain 5	0.00–100.00	0.00	-	☆
B6-19	Read gain 5	0.00–100.00	0.00	-	☆
B6-20	Source address 6	0–65535	0	-	☆
B6-21	Mapping address 6	0–65535	0	-	☆
B6-22	Write gain 6	0.00–100.00	0.00	-	☆

Parameters

Para. No.	Name	Value Range	Default	Unit	Property
B6-23	Read gain 6	0.00–100.00	0.00	-	☆
B6-24	Source address 7	0–65535	0	-	☆
B6-25	Mapping address 7	0–65535	0	-	☆
B6-26	Write gain 7	0.00–100.00	0.00	-	☆
B6-27	Read gain 7	0.00–100.00	0.00	-	☆
B6-28	Source address 8	0–65535	0	-	☆
B6-29	Mapping address 8	0–65535	0	-	☆
B6-30	Write gain 8	0.00–100.00	0.00	-	☆
B6-31	Read gain 8	0.00–100.00	0.00	-	☆
B6-32	Source address 9	0–65535	0	-	☆
B6-33	Mapping address 9	0–65535	0	-	☆
B6-34	Write gain 9	0.00–100.00	0.00	-	☆
B6-35	Read gain 9	0.00–100.00	0.00	-	☆
B6-36	Source address 10	0–65535	0	-	☆
B6-37	Mapping address 10	0–65535	0	-	☆
B6-38	Write gain 10	0.00–100.00	0.00	-	☆
B6-39	Read gain 10	0.00–100.00	0.00	-	☆
B6-40	Source address 11	0–65535	0	-	☆
B6-41	Mapping address 11	0–65535	0	-	☆
B6-42	Write gain 11	0.00–100.00	0.00	-	☆
B6-43	Read gain 11	0.00–100.00	0.00	-	☆
B6-44	Source address 12	0–65535	0	-	☆
B6-45	Mapping address 12	0–65535	0	-	☆
B6-46	Write gain 12	0.00–100.00	0.00	-	☆
B6-47	Read gain 12	0.00–100.00	0.00	-	☆
B6-48	Source address 13	0–65535	0	-	☆
B6-49	Mapping address 13	0–65535	0	-	☆
B6-50	Write gain 13	0.00–100.00	0.00	-	☆
B6-51	Read gain 13	0.00–100.00	0.00	-	☆
B6-52	Source address 14	0–65535	0	-	☆
B6-53	Mapping address 14	0–65535	0	-	☆
B6-54	Write gain 14	0.00–100.00	0.00	-	☆
B6-55	Read gain 14	0.00–100.00	0.00	-	☆
B6-56	Source address 15	0–65535	0	-	☆
B6-57	Mapping address 15	0–65535	0	-	☆
B6-58	Write gain 15	0.00–100.00	0.00	-	☆
B6-59	Read gain 15	0.00–100.00	0.00	-	☆
B6-60	Source address 16	0–65535	0	-	☆
B6-61	Mapping address 16	0–65535	0	-	☆
B6-62	Write gain 16	0.00–100.00	0.00	-	☆

Para. No.	Name	Value Range	Default	Unit	Property
B6-63	Read gain 16	0.00–100.00	0.00	-	☆
B6-64	Source address 17	0–65535	0	-	☆
B6-65	Mapping address 17	0–65535	0	-	☆
B6-66	Write gain 17	0.00–100.00	0.00	-	☆
B6-67	Read gain 17	0.00–100.00	0.00	-	☆
B6-68	Source address 18	0–65535	0	-	☆
B6-69	Mapping address 18	0–65535	0	-	☆
B6-70	Write gain 18	0.00–100.00	0.00	-	☆
B6-71	Read gain 18	0.00–100.00	0.00	-	☆
B6-72	Source address 19	0–65535	0	-	☆
B6-73	Mapping address 19	0–65535	0	-	☆
B6-74	Write gain 19	0.00–100.00	0.00	-	☆
B6-75	Read gain 19	0.00–100.00	0.00	-	☆
B6-76	Source address 20	0–65535	0	-	☆
B6-77	Mapping address 20	0–65535	0	-	☆
B6-78	Write gain 20	0.00–100.00	0.00	-	☆
B6-79	Read gain 20	0.00–100.00	0.00	-	☆
B6-80	Source address 21	0–65535	0	-	☆
B6-81	Mapping address 21	0–65535	0	-	☆
B6-82	Write gain 21	0.00–100.00	0.00	-	☆
B6-83	Read gain 21	0.00–100.00	0.00	-	☆
B6-84	Source address 22	0–65535	0	-	☆
B6-85	Mapping address 22	0–65535	0	-	☆
B6-86	Write gain 22	0.00–100.00	0.00	-	☆
B6-87	Read gain 22	0.00–100.00	0.00	-	☆
B6-88	Source address 23	0–65535	0	-	☆
B6-89	Mapping address 23	0–65535	0	-	☆
B6-90	Write gain 23	0.00–100.00	0.00	-	☆
B6-91	Read gain 23	0.00–100.00	0.00	-	☆
B6-92	Source address 24	0–65535	0	-	☆
B6-93	Mapping address 24	0–65535	0	-	☆
B6-94	Write gain 24	0.00–100.00	0.00	-	☆
B6-95	Read gain 24	0.00–100.00	0.00	-	☆
B6-96	Source address 25	0–65535	0	-	☆
B6-97	Mapping address 25	0–65535	0	-	☆
B6-98	Write gain 25	0.00–100.00	0.00	-	☆
B6-99	Read gain 25	0.00–100.00	0.00	-	☆
Group U0: Basic Monitoring Parameters					
U0-00	Running frequency (Hz)	0.00–320.00 Hz	-	Hz	

Parameters

Para. No.	Name	Value Range	Default	Unit	Property
U0-01	Frequency reference (Hz)	0.00–320.00 Hz	-	Hz	
U0-02	Bus voltage (V)	0.0–3000.0 V	-	V	
U0-03	Output voltage (V)	0–1140 V	-	V	
U0-04	Output current (A)	0.00–655.35 A (AC drive power: ≤ 55 kW) 0.0–6553.5 A (AC drive power: > 55 kW)	-	A	
U0-05	Output power (kW)	0.0–3276.7 kW	-	kW	
U0-06	Output torque (%)	–200.0% to +200.0%	-	%	
U0-07	DI state	0x0000 to 0x7FFF	-		
U0-08	DO state	0x0000 to 0x03FF	-		
U0-09	AI1 voltage (V)	0.00–10.57 V	-	V	
U0-10	AI2 voltage (V)	0.00–10.57 V	-	V	
U0-11	AI3 voltage (V)	0.00–10.57 V	-	V	
U0-12	Count value	1–65535	-		
U0-13	Length value	1–65535	-		
U0-14	Load speed display	0 to rated motor speed	-		
U0-15	PID reference	0–65535	-		
U0-16	PID feedback	0–65535	-		
U0-17	PLC stage	0–15	-		
U0-18	Pulse input reference (kHz)	0.00–100.00 kHz	-	kHz	
U0-19	Feedback speed (Hz)	–500.0 Hz to +500.0 Hz (tens position of the value of F7-12: 1)/ –320.00 Hz to +320.00 Hz (tens position of the value of F7-12: 2)	-	Hz	
U0-20	Remaining running time	0.0–6500.0 min	-	min	
U0-21	AI1 voltage before correction	0.000–10.570 V	-	V	
U0-22	AI2 voltage (V)/current (mA) before correction	0.000–10.570 V 0.000–20.000 mA	-	V	
U0-23	AI3 voltage before correction	–10.570 V to +10.570 V	-	V	
U0-24	Linear speed	0–65535	-	m/min	
U0-25	Current power-on time	0–65000 min	-	min	
U0-26	Current running time	0.0–6500.0 min	-	min	
U0-27	Pulse input reference (Hz)	0–65535 Hz	-	Hz	
U0-28	Communication	-100.00% to 100.00%	-	%	

Para. No.	Name	Value Range	Default	Unit	Property
U0-29	Encoder feedback speed (Hz)	-320.00 Hz to 320.00 Hz (tens position of the value of F7-12: 2)/ -500.0 Hz to 500.0 Hz (tens position of the value of F7-12: 1)	-	Hz	
U0-30	Display of main frequency X	0.00-500.00 Hz	-	Hz	
U0-31	Display of auxiliary frequency Y	0.00-500.00 Hz	-	Hz	
U0-32	Any memory address	0-65535	-		
U0-33	Synchronous motor rotor position	0.0° to 359.9°	-	°	
U0-34	Motor temperature	0°C to 200°C	-	°C	
U0-35	Target torque (%)	-200.0% to +200.0%	-	%	
U0-36	Resolver position	0-4095	-		
U0-37	Power factor angle	0.0-6553.5	-		
U0-38	ABZ position	0-65535	-		
U0-39	Target voltage upon V/f separation	0 V to rated motor voltage	-	V	
U0-40	Output voltage upon V/f separation	0 V to rated motor voltage	-	V	
U0-41	DI state display	0-65535	-		
U0-42	DO state display	0-65535	-		
U0-43	DI function state display 1 (functions 01 to 40)	0-65535	-		
U0-44	DI function state display 2 (functions 41 to 80)	0-65535	-		
U0-45	Fault information	0-51	-		
U0-46	Inverter unit temperature	0	-	°C	
U0-47	PTC channel voltage before correction	0	-		
U0-48	PTC channel voltage after correction	0	-		
U0-49	Number of offset pulses of position lock	0	-		
U0-50	Roll diameter	0	-	mm	
U0-51	Tension (after taper setting)	0	-	N	
U0-58	Z signal counting	0-65535	-		
U0-59	Frequency reference (%)	-100.00% to 100.00%	-	%	

Parameters

Para. No.	Name	Value Range	Default	Unit	Property
U0-60	Running frequency (%)	-100.00% to 100.00%	-	%	
U0-61	AC drive state		-		
U0-62	Current fault code	0-99	-		
U0-63	Running frequency (after droop)	0	-	Hz	
U0-64	Back EMF	0	-	V	
U0-65	Stator resistance auto-tuning upon startup	0	-		
U0-66	Communication extension card model	0-65535	-		
U0-67	Communication extension card software version	0-65535	-		
U0-68	AC drive state on the communication extension card	0-65535	-		
U0-69	Frequency transmitted to the communication extension card/0.01 Hz	0.00-655.35	-		
U0-70	Speed transmitted to the communication extension card/RPM	0-65535	-		
U0-71	Current specific to communication extension card (A)	0-65535	-		
U0-72	Communication card error state	0-65535	-		
U0-73	Target torque before filter	0	-		
U0-74	Target torque after filter	0	-		
U0-75	Torque reference after acceleration/ deceleration	0	-		
U0-76	Torque upper limit in the motoring state	0	-		
U0-77	Torque upper limit in the generating state	0	-		
U0-80	EtherCAT slave name	0	-		
U0-81	EtherCAT slave alias	0	-		
U0-82	EtherCAT ESM transmission fault code	0	-		
U0-83	EtherCAT XML file version	0	-		
U0-84	Times of EtherCAT synchronization loss	0	-		

Para. No.	Name	Value Range	Default	Unit	Property
U0-85	Maximum error value and invalid frames of EtherCAT port 0 per unit time	0	-		
U0-86	Maximum error value and invalid frames of EtherCAT port 1 per unit time	0	-		
U0-87	Maximum forwarding error of EtherCAT port per unit time	0	-		
U0-88	Maximum EtherCAT data frame processing unit error per unit time	0	-		
U0-89	Maximum link loss of EtherCAT port per unit time	0	-		
U0-96	Status parameter 1 (performance transmission)	0	-		
U0-97	Status parameter 2 (performance transmission)	0	-		
Group U1: Tension Control Monitoring Parameters					
U1-00	Linear speed	0	-	m/min	
U1-01	Current roll diameter	0	-	mm	
U1-02	Linear speed synchronous frequency	0	-	Hz	
U1-03	PID output frequency	0	-	N	
U1-04	Current tension reference	0	-	N	
U1-05	Tension reference after taper setting	0	-	-	
U1-06	Open-loop torque	0	-	-	
U1-07	PID output torque	0	-	-	
U1-08	Tension control mode	0	-	-	
U1-09	PID reference	0	-	-	
U1-10	PID feedback	0	-	-	
U1-11	Kp output	0	-	mm	
U1-12	Ki output	0	-	Hz	
U1-13	Kd output	0	-	Hz	
U1-14	Tension time	0	-	-	
U1-15	Winding/Unwinding mode	0	-	-	

4.2 List of Monitoring Parameters

Table 4-1 Monitoring parameters

Para. No.	Name	Basic Unit	Communication Address
Group U0: Basic Monitoring Parameters			
U0-00	Running frequency (Hz)	0.01 Hz	7000H
U0-01	Frequency reference (Hz)	0.01 Hz	7001H
U0-02	Bus voltage (V)	0.1 V	7002H
U0-03	Output voltage (V)	1 V	7003H
U0-04	Output current (A)	0.1 A	7004H
U0-05	Output power (kW)	0.1 kW	7005H
U0-06	Output torque (%)	0.1%	7006H
U0-07	DI state	1	7007H
U0-08	DO state	1	7008H
U0-09	AI1 voltage (V)	0.01 V	7009H
U0-10	AI2 voltage (V)	0.01 V	700AH
U0-11	AI3 voltage (V)	0.01 V	700BH
U0-12	Count value	1	700CH
U0-13	Length value	1	700DH
U0-14	Load speed display	1	700EH
U0-15	PID reference	1	700FH
U0-16	PID feedback	1	7010H
U0-17	PLC stage	1	7011H
U0-18	Pulse input reference (kHz)	0.01 kHz	7012H
U0-19	Feedback speed (Hz)	0.01 Hz	7013H
U0-20	Remaining running time	0.1 min	7014H
U0-21	AI1 voltage before correction	0.001 V	7015H
U0-22	AI2 voltage (V)/current (mA) before correction	0.001 V	7016H
U0-23	AI3 voltage before correction	0.001 V	7017H
U0-24	Linear speed	1 m/min	7018H
U0-25	Current power-on time	1 min	7019H
U0-26	Current running time	0.1 min	701AH
U0-27	Pulse input reference (Hz)	1 Hz	701BH
U0-28	Communication	0.01%	701CH
U0-29	Encoder feedback speed (Hz)	0.01 Hz	701DH
U0-30	Display of main frequency X	0.01 Hz	701EH
U0-31	Display of auxiliary frequency Y	0.01 Hz	701FH
U0-32	Any memory address	1	7020H
U0-33	Synchronous motor rotor position	0.1°	7021H
U0-34	Motor temperature	1°C	7022H

Para. No.	Name	Basic Unit	Communication Address
U0-35	Target torque (%)	0.1%	7023H
U0-36	Resolver position	1	7024H
U0-37	Power factor angle	0.1	7025H
U0-38	ABZ position	1	7026H
U0-39	Target voltage upon V/f separation	1 V	7027H
U0-40	Output voltage upon V/f separation	1 V	7028H
U0-41	DI state display	1	7029H
U0-42	DO state display	1	702AH
U0-43	DI function state display 1 (functions 01 to 40)	1	702BH
U0-44	DI function state display 2 (functions 41 to 80)	1	702CH
U0-45	Fault information	1	702DH
U0-46	Inverter unit temperature	1°C	702EH
U0-47	PTC channel voltage before correction	0.001	702FH
U0-48	PTC channel voltage after correction	0.001	7030H
U0-49	Number of offset pulses of position lock	1	7031H
U0-50	Roll diameter	1 mm	7032H
U0-51	Tension (after taper setting)	1 N	7033H
U0-58	Z signal counting	1	703AH
U0-59	Frequency reference (%)	0.01%	703BH
U0-60	Running frequency (%)	0.01%	703CH
U0-61	AC drive state	1	703DH
U0-62	Current fault code	1	703EH
U0-63	Running frequency (after droop)	0.01 Hz	703FH
U0-64	Back EMF	0.1 V	7040H
U0-65	Stator resistance auto-tuning upon startup	1	7041H
U0-66	Communication extension card model	1	7042H
U0-67	Communication extension card software version	1	7043H
U0-68	AC drive state on the communication extension card	1	7044H
U0-69	Frequency transmitted to the communication extension card/0.01 Hz	1	7045H
U0-70	Speed transmitted to the communication extension card/RPM	1	7046H
U0-71	Current specific to communication extension card (A)	1	7047H
U0-72	Communication card error state	1	7048H
U0-73	Target torque before filter	0.1	7049H
U0-74	Target torque after filter	0.1	704AH

Parameters

Para. No.	Name	Basic Unit	Communication Address
U0-75	Torque reference after acceleration/ deceleration	0.1	704BH
U0-76	Torque upper limit in the motoring state	0.1	704CH
U0-77	Torque upper limit in the generating state	0.01	704DH
U0-80	EtherCAT slave name	1	7050H
U0-81	EtherCAT slave alias	1	7051H
U0-82	EtherCAT ESM transmission fault code	1	7052H
U0-83	EtherCAT XML file version	0.01	7053H
U0-84	Times of EtherCAT synchronization loss	1	7054H
U0-85	Maximum error value and invalid frames of EtherCAT port 0 per unit time	1	7055H
U0-86	Maximum error value and invalid frames of EtherCAT port 1 per unit time	1	7056H
U0-87	Maximum forwarding error of EtherCAT port per unit time	1	7057H
U0-88	Maximum EtherCAT data frame processing unit error per unit time	1	7058H
U0-89	Maximum link loss of EtherCAT port per unit time	1	7059H
U0-96	No-load current of asynchronous motor vector online observation	0.1	7060H
U0-97	Mutual inductance of asynchronous motor vector online observation	0.1	7061H
Group U1: Tension Control Monitoring Parameters			
U1-00	Linear speed	0.1 m/min	7100H
U1-01	Current roll diameter	0.1 mm	7101H
U1-02	Linear speed synchronous frequency	0.01 Hz	7102H
U1-03	PID output frequency	0.01 N	7103H
U1-04	Current tension reference	1 N	7104H
U1-05	Tension reference after taper setting	1	7105H
U1-06	Open-loop torque	0.1	7106H
U1-07	PID output torque	0.1	7107H
U1-08	Tension control mode	1	7108H
U1-09	PID reference	0.1	7109H
U1-10	PID feedback	0.1	710AH
U1-11	Kp output	1 mm	710BH
U1-12	Ki output	1 Hz	710CH
U1-13	Kd output	1 Hz	710DH
U1-14	Tension time	1	710EH
U1-15	Winding/Unwinding mode	1	710FH
Group U2: Position Control Monitoring Parameters			
U2-60	Real-time position deviation during position control	1	723CH

Para. No.	Name	Basic Unit	Communication Address
U2-61	Valid home tag	1	723DH
U2-62	Home position (low 16 bits)	1	723EH
U2-63	Home position (high 16 bits)	1	723FH
U2-64	Z signal position (low 16 bits)	1	7240H
U2-65	Z signal position (high 16 bits)	1	7241H
U2-66	Current position reference segment	0.01	7242H
U2-67	Proximity output flag	1	7243H
U2-68	Completion output flag	1	7244H
U2-69	Position control mode	1	7245H
U2-70	Pulses per revolution of encoder	0.01	7246H
U2-71	Pulses per revolution of spindle	1	7247H
U2-72	Pulses per revolution of motor	1	7248H
U2-73	Current encoder indexing	1	7249H
U2-74	Current encoder indexing (angle)	1	724AH
U2-75	Communication running frequency (%)	1	724BH
U2-76	Communication position reference	1	724CH
U2-77	Communication position reference	1	724DH
U2-78	Position control state	1	724EH
U2-79	Real-time position deviation during position control	1	724FH
U2-80	Relative home position direction	1	7250H
U2-81	Relative home position deviation (low 16 bits)	1	7251H
U2-82	Relative home position deviation (high 16 bits)	1	7252H
U2-83	Position	1	7253H
U2-84	Speed	1	7254H
U2-85	Current spindle indexing	1	7255H
U2-86	Current spindle indexing (angle)	1	7256H
U2-87	Position control pause	1	7257H
U2-88	Communication command word 731EH data	1	7258H
U2-89	Position lock operation flag in position control	1	7259H
U2-90	Position control frequency upper limit	0.01	725AH
U2-91	Static spindle flag	1	725BH
U2-92	Home loss counting during home correction	1	725CH
U2-93	Encoder Z signal counter	1	725DH
U2-95	Encoder pulse counting (low 16 bits)	1	725FH
U2-96	Encoder pulse counting (high 16 bits)	1	7260H
U2-98	AC drive operation mode	1	7262H
U2-99	Position control frequency reference	1	7263H



19011579A04

The information in this user guide is subject to change without notice.
Copyright © Shenzhen Inovance Technology Co., Ltd.

Shenzhen Inovance Technology Co., Ltd.
www.inovance.com

Add.: Building E, Hongwei Industry Park, Liuxian Road, Baocheng No. 70 Zone, Bao'an District, Shenzhen

Tel: +86-755-2979 9595 **Fax:** +86-755-2961 9897

Suzhou Inovance Technology Co., Ltd.
www.inovance.com

Add.: No. 16 Youxiang Road, Yuexi Town, Wuzhong District, Suzhou 215104, P.R. China

Tel: +86-512-6637 6666 **Fax:** +86-512-6285 6720